

# NETBOOK PRO

## Win CE 4.2 User Manual

October 10, 2003 P/N 8100012 Rev A



*ISO 9001 Certified  
Quality Management System*



**© Copyright 2003 by Psion Teklogix Inc., Mississauga, Ontario**

This document and the information it contains is the property of Psion Teklogix Inc., is issued in strict confidence, and is not to be reproduced or copied, in whole or in part, except for the sole purpose of promoting the sale of Psion Teklogix manufactured goods and services. Furthermore, this document is not to be used as a basis for design, manufacture, or sub-contract, or in any manner detrimental to the interests of Psion Teklogix Inc.

*All trademarks are the property of their respective holders.*

## **Return-To-Factory Warranty**

Psion Teklogix warrants a return-to-factory warranty for a period of one year. In some regions, the warranty exceeds this period. Please contact your local Psion Teklogix office for details. For a list of offices, please refer to Appendix A: “Support Services And Worldwide Offices”. The warranty on Psion Teklogix manufactured equipment does not extend to any product that has been tampered with, altered, or repaired by any person other than an employee of an authorized Psion Teklogix service organization. See Psion Teklogix terms and conditions of sale for full details.

## **Service**

When requesting service, please provide information concerning the nature of the failure and the manner in which the equipment was used when the failure occurred. Type, model, and serial number should also be provided. Before returning any products to the factory, call the Customer Services Group for a Return Authorization number.

## **Support Services**

Psion Teklogix provides a complete range of product support services to its customers. For detailed information, please refer to Appendix A: “Support Services And Worldwide Offices”.

## **Disclaimer**

Every effort has been made to make this material complete, accurate, and up-to-date. Psion Teklogix Inc. reserves the right to make changes without notice and shall not be responsible for any damages, including but not limited to consequential damages, caused by reliance on the material presented, including but not limited to typographical errors.



# TABLE OF CONTENTS

Approvals and Safety Summary . . . . .	vii
--	-----

## Chapter 1: Introduction

1.1 About This Manual . . . . .	3
1.2 Text Conventions . . . . .	4
1.3 Applications Installed On The NETBOOK PRO. . . . .	4
1.3.1 About ActiveSync . . . . .	5
1.4 Caring For The NETBOOK PRO. . . . .	5

## Chapter 2: Getting Started

2.1 Features Of The NETBOOK PRO . . . . .	11
2.2 Turning On And Off . . . . .	11
2.3 Passwords . . . . .	12
2.4 Finding And Using The Stylus . . . . .	13
2.5 Power Management. . . . .	14
2.5.1 Power Properties . . . . .	15
2.5.1.1 Battery . . . . .	16
2.5.1.2 Battery Calibration . . . . .	16
2.5.1.3 Power Saving Schemes . . . . .	18
2.5.1.4 The Advanced Tab . . . . .	21
2.5.2 Battery Care . . . . .	22
2.5.2.1 Fitting The Main Battery. . . . .	22
2.5.2.2 Charging The NETBOOK PRO Battery Pack . . . . .	22
2.5.2.3 Changing Battery Packs . . . . .	22
2.5.2.4 Prolonging Battery Life . . . . .	23
2.5.2.5 The Internal Backup Battery . . . . .	24
2.6 Memory Cards . . . . .	24
2.6.1 Inserting And Removing An MMC Or SD Card . . . . .	25

## Contents

2.6.2	Inserting And Removing A Compact Flash Card . . . . .	26
2.6.3	Inserting And Removing A PCMCIA Card . . . . .	27
2.7	Connecting USB Accessories . . . . .	28
2.8	The Start Button And Taskbar . . . . .	29
2.9	Resetting The NETBOOK PRO. . . . .	30
2.9.1	Performing A Soft Reset . . . . .	31
2.9.2	Performing A Hard Reset. . . . .	32
2.10	First Steps . . . . .	33
2.10.1	Navigating Between Files And Folders. . . . .	33
2.10.2	Starting Programs . . . . .	34
2.10.3	Programs And Files. . . . .	34
2.10.4	Entering Information . . . . .	34
2.10.5	Using Menus . . . . .	34
2.10.6	Using Dialogs. . . . .	35
2.10.6.1	Dialog Buttons . . . . .	36
2.10.7	Copying Information Between Programs. . . . .	36

## Chapter 3: Configuring The Unit

3.1	Things To Do First. . . . .	39
3.1.1	Entering Owner and Password Information . . . . .	39
3.1.2	Setting The Time, Date, And Time Zone . . . . .	39
3.2	Things To Do Next . . . . .	40
3.2.1	Setting Up ActiveSync . . . . .	40
3.2.1.1	Partnerships . . . . .	40
3.2.1.2	Connecting Via RS232 Serial. . . . .	41
3.2.1.3	Connecting Via Infrared (IrDA) . . . . .	42
3.2.1.4	Connecting Via Ethernet (802.11b). . . . .	42
3.2.2	Backing Up To A PC . . . . .	43
3.2.2.1	Backing Up To A Memory Card . . . . .	43
3.2.2.2	Restoring Files From A Memory-Card Backup . . . . .	43
3.2.3	Exploring The Control Panel . . . . .	44
3.2.4	Securing Your Information . . . . .	45

## Chapter 4: Files, Folders, and Programs

4.1	Introduction . . . . .	49
4.2	Moving Around . . . . .	49
4.3	Opening Files, Folders And Programs . . . . .	49
4.4	Closing Programs/Files . . . . .	50
4.5	Creating New Folders. . . . .	50
4.5.1	Creating New Files. . . . .	51
4.6	Start Menu - Documents . . . . .	51
4.7	Changing File Attributes . . . . .	51
4.8	Managing Folders. . . . .	52
4.9	Memory-Card Folders . . . . .	53
4.10	The Flash Folder . . . . .	54
4.11	Checking System Memory Use. . . . .	55
4.11.1	What Happens When System Memory Is Full? . . . . .	55
4.11.2	Additional Memory And Programs . . . . .	55
4.12	The Storage Manager . . . . .	56
4.12.1	Formatting A Memory Card . . . . .	56
4.12.2	Creating Partitions . . . . .	57
4.12.3	Partition Management . . . . .	59

## Chapter 5: Using The PC Connection

5.1	Introduction . . . . .	65
5.2	Using ActiveSync. . . . .	65
5.3	Getting Help. . . . .	66
5.3.1	Where Can I Find More Help?. . . . .	66
5.3.2	Tips On Using ActiveSync Help. . . . .	66
5.4	Working With Your Files . . . . .	67
5.4.1	Looking At Files On Your NETBOOK PRO . . . . .	67
5.4.2	Copying A File Using Drag And Drop. . . . .	67
5.4.3	Copying A File Using Copy And Paste . . . . .	68
5.4.4	Opening NETBOOK PRO Files From Your PC. . . . .	69
5.5	Backing Up Your NETBOOK PRO With ActiveSync . . . . .	69
5.5.1	Performing Your First Backup . . . . .	69

## Contents

5.5.2	Performing Regular Backups . . . . .	70
5.6	Synchronizing Your NETBOOK PRO . . . . .	70
5.6.1	What Is Synchronization?. . . . .	70
5.6.2	Synchronizing Your NETBOOK PRO . . . . .	70
5.6.2.1	Creating The Partnership . . . . .	70
5.6.3	Using An Existing Partnership . . . . .	73
5.7	On-Schedule Outlook Sync . . . . .	73

## Chapter 6: Configuring Communications

6.1	Introduction . . . . .	77
6.2	802.11b Radio Configuration . . . . .	77
6.3	GSM/GPRS Radio Configuration . . . . .	80
6.4	Bluetooth Radio Configuration . . . . .	85
6.4.1	NETBOOK PRO Bluetooth Settings . . . . .	86
6.5	Internet And E-Mail Settings . . . . .	89
6.5.1	Overview . . . . .	89
6.5.1.1	Using The Internet On The NETBOOK PRO . . . . .	89
6.5.1.2	Using E-mail On The NETBOOK PRO . . . . .	89
6.5.1.3	Types Of E-mail Account. . . . .	90
6.5.1.4	If You Don't Have An Internet/E-mail Account . . . . .	90
6.5.1.5	Glossary Of Terms . . . . .	91
6.5.2	Setting Up Your NETBOOK PRO . . . . .	92
6.5.2.1	How To Use Internet Explorer/Inbox. . . . .	92
6.5.2.2	Getting Help . . . . .	92
6.5.2.3	What Information Do I Need? . . . . .	93
6.5.3	Setting Up E-mail On NETBOOK PRO . . . . .	94
6.5.3.1	Connecting The Modem . . . . .	94
6.5.3.2	Setting Up Dialing . . . . .	95
6.5.3.3	Setting Up The Internet Service . . . . .	96
6.5.3.4	Setting Up The Modem. . . . .	96
6.5.3.5	Setting Up The E-mail Program . . . . .	97

## Chapter 7: Troubleshooting And Tips

7.1	General Tips . . . . .	101
-----	------------------------	-----



7.1.1	Times Aren't Correct In The Time Program . . . . .	101
7.1.2	If You Forget Your Password. . . . .	101
7.1.3	The NETBOOK PRO Doesn't Turn On/Off. . . . .	101
7.1.4	Resetting The NETBOOK PRO . . . . .	102
7.1.5	Battery Life Of The NETBOOK PRO . . . . .	102
	7.1.5.1 Charging Times . . . . .	103
7.2	ActiveSync Connection Problems	
	Using Windows® 95/98/NT 4.0 . . . . .	103
7.2.1	Tips When Installing ActiveSync . . . . .	103
7.2.2	Basic Troubleshooting For Your NETBOOK PRO . . . . .	104
7.2.3	Basic Troubleshooting For Your PC . . . . .	104
7.2.4	Device Conflicts . . . . .	106
7.2.5	Fax/Modem On COM 1/2/3/4 . . . . .	108
7.2.6	Temp Folder . . . . .	109
7.3	Troubleshooting ActiveSync	
	Synchronization Problems . . . . .	111
7.3.1	Basic Troubleshooting For Synchronization Problems . . . . .	111
7.3.2	Other Things To Try . . . . .	112

## Chapter 8: Specifications

8.1	Hardware Specifications . . . . .	115
8.1.1	Physical. . . . .	115
8.1.2	Environmental Characteristics . . . . .	115
8.1.3	Standard Display . . . . .	116
8.1.4	Power Requirements . . . . .	116
8.1.5	Standard Processor And Memory . . . . .	116
8.1.6	Miscellaneous . . . . .	116
8.2	Standard Operating System . . . . .	116

# Appendices

## Appendix A: Support Services And Worldwide Offices

A.1	Technical Support . . . . .	A-1
A.2	Product Repairs . . . . .	A-1
A.3	WorldWide Offices. . . . .	A-2
	Company Headquarters And Canadian Service Centre . . . . .	A-2
	Americas . . . . .	A-2
	North American Headquarters And U.S. Service Centre . . . . .	A-2
	International Subsidiaries . . . . .	A-2
A.4	Worldwide Web . . . . .	A-3

## Appendix B: Program License Agreement

B.1	PROGRAM LICENSE AGREEMENT. . . . .	B-3
B.2	MICROSOFT END USER LICENSE AGREEMENT (EULA):. . . . .	B-4

<b>Index</b> . . . . .	<b>I</b>
------------------------	----------

# APPROVALS AND SAFETY SUMMARY

## DECLARATION OF CONFORMITY

Product:	<b>NETBOOK PRO</b>
Application of Council Directives:	EMC Directive: 89/336/EEC Low Voltage Directive: 73/23/EEC
Conformity Declared to Standards:	EN 55022: 1998; Class B; EN 55024: 1998; EN 61000-4-2; $\pm 4$ kV CD; $\pm 8$ kV AD EN 61000-4-3; 3V/m, 80-1000 MHz, 900 MHz EN 61000-4-4; $\pm 1$ kV Power lines EN 61000-4-5; $\pm 2$ kV Common; $\pm 1$ kV Differential mode EN 61000-4-6; $3V_{RMS}$ , 150 kHz-80 MHz EN 61000-4-11; AC Mains Ports EN 61000-3-2; EN 61000-3-3 EN 60950: 1992 + A1 + A2 + A3 + A4 + A11
Manufacturer:	PSION TEKLOGIX INC. 2100 Meadowvale Blvd. Mississauga, Ontario; Canada L5N 7J9
Year of Manufacture:	2003
Manufacturer's Address in the European Community:	PSION TEKLOGIX S.A. La Duranne; 135 Rue Rene Descartes BP 421000 13591 Aix-En-Provence Cedex 3; France
Type of Equipment:	Information Technology Equipment
Equipment Class:	Commercial and Light Industrial
Manufacturer:	Psion Teklogix Inc. Ontario
Legal Representative in Europe:	Psion Teklogix S.A. France

## FCC INFORMATION FOR THE USA

### FCC DECLARATION OF CONFORMITY (DoC)

Applicant's Name & Address: PSION TEKLOGIX  
2100 Meadowvale Blvd.  
Mississauga, Ontario, Canada L5N 7J9  
Telephone No.: (905) 813-9900

US Representative's Name & Address: Psion Teklogix Corp.  
1810 Airport Exchange Blvd., Suite 500  
Erlanger, Kentucky, 41018, USA  
Telephone No.: (859) 371-6006

Equipment Type/ Environment Use: Computing Devices for Home and Office Use

Trade Name / Model No.: **NETBOOK PRO**

Year of Manufacture: 2003

Standard(s) to which Conformity is Declared:

The **NETBOOK PRO**, supplied by Psion Teklogix, has been tested and found to comply with **FCC PART 15, SUBPART B - UNINTENTIONAL RADIATORS, CLASS B COMPUTING DEVICES FOR HOME & OFFICE USE.**

Applicant: Psion Teklogix Inc.  
Mississauga, Ontario, Canada

Legal Representative in US: Psion Teklogix Corp.  
Erlanger, Kentucky, USA

## **CE MARKING**

When used in a residential, commercial or light industrial environment, the product and its approved UK and European peripherals fulfill all requirements for CE marking.

### **R&TTE DIRECTIVE 1999/5/EC**

This equipment complies with the essential requirements of EU Directive 1999/5/EC (Declaration available: [www.pSIONTEKLOGIX.COM](http://www.pSIONTEKLOGIX.COM)).

Cet équipement est conforme aux principales caractéristiques définies dans la Directive européenne RTTE 1999/5/CE. (Déclaration disponible sur le site: [www.pSIONTEKLOGIX.COM](http://www.pSIONTEKLOGIX.COM)).

Die Geräte erfüllen die grundlegenden Anforderungen der RTTE-Richtlinie (1999/5/EG). (Den Wortlaut der Richtlinie finden Sie unter: [www.pSIONTEKLOGIX.COM](http://www.pSIONTEKLOGIX.COM)).

Questa apparecchiatura è conforme ai requisiti essenziali della Direttiva Europea R&TTE 1999/5/CE. (Dichiarazione disponibile sul sito: [www.pSIONTEKLOGIX.COM](http://www.pSIONTEKLOGIX.COM)).

Este equipo cumple los requisitos principales de la Directiva 1995/5/CE de la UE, “Equipos de Terminales de Radio y Telecomunicaciones”. (Declaración disponible en: [www.pSIONTEKLOGIX.COM](http://www.pSIONTEKLOGIX.COM)).

Este equipamento cumpre os requisitos essenciais da Directiva 1999/5/CE do Parlamento Europeu e do Conselho (Directiva RTT). (Declaração disponível no endereço: [www.pSIONTEKLOGIX.COM](http://www.pSIONTEKLOGIX.COM)).

Ο εξοπλισμός αυτός πληροί τις βασικές απαιτήσεις της κοινοτικής οδηγίας EU R&TTE 1999/5/EK. (Η δήλωση συμμόρφωσης διατίθεται στη διεύθυνση: [www.pSIONTEKLOGIX.COM](http://www.pSIONTEKLOGIX.COM))

Deze apparatuur voldoet aan de noodzakelijke vereisten van EU-richtlijn betreffende radioapparatuur en telecommunicatie-eindapparatuur 199/5/EG. (verklaring beschikbaar: [www.pSIONTEKLOGIX.COM](http://www.pSIONTEKLOGIX.COM)).

Dette udstyr opfylder de Væsentlige krav i EU's direktiv 1999/5/EC om Radio- og teleterminaludstyr. (Erklæring findes på: [www.pSIONTEKLOGIX.COM](http://www.pSIONTEKLOGIX.COM)).

Dette utstyret er i overensstemmelse med hovedkravene i R&TTE-direktivet (1999/5/EC) fra EU. (Erklæring finnes på: [www.pSIONTEKLOGIX.COM](http://www.pSIONTEKLOGIX.COM)).

## **Approvals And Safety Summary**

Utrustningen uppfyller kraven för EU-direktivet 1999/5/EC om ansluten teleutrustning och ömsesidigt erkännande av utrustningens överensstämmelse (R&TTE). (Förklaringen finns att läsa på: [www.pSIONteklogix.com](http://www.pSIONteklogix.com)).

Tämä laite vastaa EU:n radio- ja telepäätelaitedirektiivin (EU R&TTE Directive 1999/5/EC) vaatimuksia. (Julkilausuma nähtävillä osoitteessa: [www.pSIONteklogix.com](http://www.pSIONteklogix.com)).

## **FCC INFORMATION TO THE USER**

### **RADIO AND TELEVISION INTERFERENCE**

This equipment radiates radio frequency energy and if not used properly—that is, in strict accordance with the instructions in this manual—may cause interference to radio communications and television reception. It has been tested and found to comply with the limits for a Class B digital device pursuant to part 15 of the FCC Rules. Operation is subject to the following two conditions:

1. This device may not cause harmful interference, and
2. This device must accept any interference received, including interference that may cause undesired operation.

These limits are designed to provide reasonable protection against harmful interference in a residential installation. However, there is no guarantee that interference will not occur in a particular installation. If this equipment does cause harmful interference to radio or television reception, which can be determined by turning the equipment off and on, the user is encouraged to try to correct the interference by one or more of the following measures:

- Reorient or relocate the receiving antenna.
- Increase the separation distance between the equipment and the receiver.
- If you are using the equipment with a mains adaptor, plug it into an outlet which is on a different circuit from that to which the receiver is connected.
- Consult an experienced radio/TV technician for help.

For customers in the USA, the following booklet prepared by the Federal Communications Commission may be of help: “How to Identify and Resolve Radio-TV Interference Problems”. This booklet is available from the US Government Printing Office, Washington, DC 20402 - Stock No 004-000-00345-4.

### RADIO FREQUENCY EMISSIONS

Do not use in aircraft or hospitals. Some equipment in hospitals and aircraft are not shielded from radio frequency energy. Do not use the NETBOOK PRO on board aircraft, or in hospitals, without first obtaining permission.

Do not use near pacemakers. The product may affect the operation of some medically implanted devices such as pacemakers, causing them to malfunction. Avoid placing your product next to such devices. Keep a minimum distance of 15 cm between the device and the product to reduce the risk of interference. If you have any reason to suspect that interference is taking place, turn off the NETBOOK PRO and contact your cardiologist for assistance.



**Note:** *In August 1996 the Federal Communications Commission (FCC) of the US adopted an updated safety standard for human exposure to radio frequency energy emitted by FCC regulated transmitters. The design of this product complies with the FCC guidelines and those standards.*

*Use of non-approved accessories may violate FCC RF exposure guidelines.*



### IMPORTANT SAFETY INSTRUCTIONS

This equipment was tested for FCC compliance under conditions that included the use of shielded cables and connectors between it and the peripherals. It is important that you use shielded cable and connectors to reduce the possibility of causing radio and television interference. Shielded cables, suitable for the NETBOOK PRO, can be obtained from an authorised Psion Teklogix dealer.

If the user modifies the equipment or its peripherals in any way, and these modifications are not approved by Psion Teklogix, the FCC may withdraw the user’s right to operate the equipment.

## **EMISSIONS INFORMATION FOR CANADA**

This Class B digital apparatus meets all requirements of the Canadian Interference-Causing Equipment Regulations.

Cet appareil numérique de la classe B respecte toutes les exigences du Règlement sur le matériel brouilleur du Canada.

## **INFRARED DEVICE SAFETY**

### **CLASS I LED PRODUCT**

This product includes an Infrared device for transmitting and receiving files from devices supporting the IrDA format. Although this invisible beam is not considered harmful, and complies with EN60825-1 (IEC825-1), we recommend the following precautions when the Infrared device is transmitting:

- Do not stare into the Infrared beam.
- Do not view directly with optical instruments.

No parts in the device may be serviced by the user.

## **BATTERY SAFETY PRECAUTIONS**

### **CAUTION!**

Danger of explosion if a NETBOOK PRO battery is incorrectly handled, charged, disposed of or replaced. Replace only with the same or equivalent type recommended by the manufacturer. Dispose of used batteries according to the instructions described in “Lithium-Ion Battery Safety Precautions” on page xiii. Carefully review all battery safety issues listed in that section.

### **VORSICHT!**

Explosionsgefahr bei unsachgemäßem Austausch der Batterie Ersatz nur durch denselben oder einen vom Hersteller empfohlenen gleichwertigen Typ. Entsorgung gebrauchter Batterien nach Angaben des Herstellers.



## LITHIUM-ION BATTERY SAFETY PRECAUTIONS

Do not store batteries at temperatures in excess of +60°C; the optimum storage temperature for maximum battery life is +10°C to +35°C.



**Important:** *It is critical that this safety information be reviewed and that all warnings be strictly followed.*

BATTERIES ARE CONSIDERED HAZARDOUS WASTE. Used batteries must be disposed of in accordance with the manufacturer's instructions, taken to an appropriate local battery recycling facility, or returned to one of the following Psion Teklogix offices for proper disposal.

Teklogix Inc.

2100 Meadowvale Blvd.

Mississauga, Ontario

Canada

L5N 7J9

Teklogix Corp.

1810 Airport Exchange Blvd.

Suite 500

Erlanger, Kentucky

USA 41018

Teklogix S.A.

Parc Club Du Golf-Bat 1.

13856 Aix-En-Provence

Cedex 3

France



**Warning:** *TO PREVENT the battery from leaking acid, generating heat or exploding, adhere to the precautions listed below.*

- Use only with the authorized Psion Teklogix power adaptor.
- Do not dispose of in fire.
- Do not incinerate or subject battery cells to temperatures in excess of 100°C (212°F). Such treatment can vaporize the liquid electrolyte causing cell rupture. Incineration may result in harmful emissions or explosion.
- Do not charge, use or store batteries below -30° C (-22° F). Batteries must be handled in accordance with all applicable state and federal laws and regulations.
- The battery incorporates built-in safety devices. To ensure their proper function, do not disassemble or alter any parts of the battery.
- Do not short-circuit the battery by directly connecting any of the exposed terminals with metal objects such as wire. Do not transport or store the battery together with metal objects such as necklaces, hair pins, etc.
- Do not use or leave the battery near a heat source such as a fire or heater.

## ***Approvals And Safety Summary***

- Do not immerse the battery in water.
- When charging, use the battery charger specifically designed for the battery.
- Do not crush, puncture, open, dismantle, or otherwise mechanically interfere with batteries.
- Do not directly solder the battery.
- Do not connect the battery to an electrical outlet, vehicle cigarette lighter, etc.
- Do not put battery into a microwave oven or pressurized container.
- Do not use the rechargeable battery in combination with non-rechargeable batteries (such as dry-cell batteries) or batteries of different capacities or brands.
- Immediately remove the battery from the device or battery charger and stop use if the battery gives off an odour, generates heat, becomes discoloured or deformed, or in any way appears abnormal during use.
- Do not continue charging the battery if it does not recharge within the specified charge time.
- The battery may burst or ignite if the battery leaks. Always ensure that it is away from any exposed flames.
- If a battery should leak, do not allow the contents to come into contact with your skin or your eyes. If it does, wash immediately with plenty of cold water and seek medical advice.
- Do not store the battery in extremely high temperatures (e.g., a vehicle, strong direct sunlight, etc.). This may cause the battery to overheat or ignite, and it may also reduce the performance and service life of the battery.
- Do not use in areas where static electricity is greater than what the manufacturer guarantees.
- Keep batteries out of reach of children.

# INTRODUCTION

# 1

1.1 About This Manual . . . . .	3
1.2 Text Conventions. . . . .	4
1.3 Applications Installed On The NETBOOK PRO . . . . .	4
1.3.1 About ActiveSync . . . . .	5
1.4 Caring For The NETBOOK PRO . . . . .	5



## 1.1 About This Manual

This manual provides information on the operation and features of the Psion Teklogix NETBOOK PRO. For additional information, refer to the NETBOOK PRO online help, or the documentation supplied with the application you are using. The manual references other user documents, where applicable.

### ***Chapter 1: Introduction***

provides an overview of this manual, NETBOOK PRO applications, including the PC connectivity software, ActiveSync, and care of the NETBOOK PRO.

### ***Chapter 2: Getting Started***

describes the NETBOOK PRO features and how to get the NETBOOK PRO ready for use, including installation of a PC Card, Compact Flash card, or MultiMedia / Secure Digital Card. Important battery installation and use information is also detailed.

### ***Chapter 3: Configuring The Unit***

provides instructions on configuring the NETBOOK PRO's security and Control Panel features. It also explains how to use ActiveSync to connect the NETBOOK PRO to a PC serially, or through Infrared or radio communication. File transfers and file synchronization can be done via ActiveSync.

### ***Chapter 4: Files, Folders, and Programs***

describes the NETBOOK PRO's file manager and how to move around and manage the information on your NETBOOK PRO.

### ***Chapter 5: Using The PC Connection***

explains how to use ActiveSync for file transfers, file synchronization and sending e-mail.

### ***Chapter 6: Configuring Communications***

instructs on the configuration of Bluetooth, GSM/GPRS, and 802.11b radios, and the programs Internet Explorer (the Internet browser) and Inbox (the e-mail application).

### ***Chapter 7: Troubleshooting And Tips***

assists in the recognition and correction of problems that you may encounter when operating the NETBOOK PRO and ActiveSync. Includes detailed information on battery use and power consumption.

**Chapter 8: Specifications**

details the physical, environmental and various operating specifications for the NETBOOK PRO.

**Appendix A: Support Services And Worldwide Offices**

presents information for technical support, contacts and the Psion Teklogix worldwide web address.

## 1.2 Text Conventions



**Note:** *Notes highlight additional helpful information.*



**Important:** *These statements provide particularly important instructions or additional information that is critical to the operation of the computer and other equipment.*



**Warning:** *These statements provide important information that may prevent injury, damage to the equipment, or loss of data.*

## 1.3 Applications Installed On The NETBOOK PRO

The NETBOOK PRO is capable of running a wide variety of applications but the ones available on your particular NETBOOK PRO depend on the purpose for which the NETBOOK PRO is provided. A number of standard applications exist and custom programs can be installed easily.

The following standard programs are available:

- **Inbox**, for sending and receiving e-mail.
- **Internet Explorer**, for browsing the World Wide Web.
- **MSN Messenger**, an instant-messaging program.
- **Pocket On-Schedule**, a personal-information manager.
- **JEM-CE**, Java ‘virtual machine’ software.
- **Stellent File Viewer**, software for viewing files.
- **Windows Explorer**, a file browser.
- **Windows Media Player**, software for viewing multimedia files.

- **Wordpad**, a word processor for writing letters and other documents.

### 1.3.1 About ActiveSync

The Microsoft PC connectivity software, ActiveSync, can be used to connect the NETBOOK PRO to PCs running Windows® 95/98/ME/2000/XP or NT 4.0. By connecting the NETBOOK PRO to a PC with a cable and running ActiveSync on the PC, you can:

- **View your NETBOOK PRO files** from Windows Explorer by using the *Mobile Device* icon in the PC's My Computer window.
- **Drag and drop files** between the NETBOOK PRO and the PC in the same way that you would between PC drives, and they will be automatically converted to the appropriate file format at the same time.
- **Synchronize e-mail and your address book** on the NETBOOK PRO with the PC to keep them in step with each other.
- **Back up** your NETBOOK PRO files to the PC, then restore them from the PC to the NETBOOK PRO again, if needed.

For detailed information, please refer to Chapter 5: "Using The PC Connection".

## 1.4 Caring For The NETBOOK PRO

### Screen

When used with the approved stylus, the NETBOOK PRO screen is very resistant to wear and impact and should last for a considerable time. Use of any object, other than the approved stylus, may result in damage to the NETBOOK PRO screen.

To maintain the life of the NETBOOK PRO screen, keep the screen clean.

To clean the screen: switch off the NETBOOK PRO and use a soft, clean, dry cloth to gently wipe the screen. (If the unit is set to turn on automatically when the screen is tapped, you should turn this preference off before cleaning the screen.)



**Warning:** *Under no circumstances use chemical solvents to clean the screen.*

### Charging

To avoid damage to the NETBOOK PRO or the NETBOOK PRO battery packs, use only Psion Teklogix approved chargers and docking stations.

## Backup Battery

The NETBOOK PRO has replaceable backup batteries designed to retain data while the main battery pack is charging or being changed over.

The backup batteries are a pair of AAA cells. These may be replaced by the user.



**Important:** *If both the main battery pack and the backup battery are allowed to fully discharge, you will lose all your information on the internal disk. However, some of your data can be protected from loss using the flash folder. Please refer to page 54 for details.*

## Drop Rating

The NETBOOK PRO is designed to survive being dropped onto carpet, from a height of 0.7 m.

Dropping the NETBOOK PRO from greater heights or onto harder surfaces may result in damage to the NETBOOK PRO.

## IP Rating

The NETBOOK PRO is rated to IP30.

## Operating Temperature

The NETBOOK PRO is designed to operate within the temperature limits of 0°C to +50°C (32°F and 120°F). Use of the NETBOOK PRO outside of these temperature limits may reduce its life. Avoid exposing the NETBOOK PRO to sudden changes in temperature, since such exposure may result in damage.



**Important:** *As a safety precaution, charging the NETBOOK PRO battery should be limited to the temperature range: 0°C to +50°C (32°F to 120°F) Outside of these limits, the safety circuits of the NETBOOK PRO battery pack will not allow the battery to charge.*

## Storage Temperature

The NETBOOK PRO is designed to be stored within the temperature ranges of -10°C to +60°C (14°F and 140°F). Storage of the NETBOOK PRO outside of these temperature limits may reduce its life.



To prolong the life of the NETBOOK PRO battery packs during normal storage, store the NETBOOK PRO (and the battery pack) between +10°C and +35°C (+50°F and +95°F).

When storing the NETBOOK PRO for a long period of time, the main battery should be removed and stored fully discharged.

## **Humidity**

The NETBOOK PRO is designed to operate in humidity ranging from 5 to 93% (non-condensing). Use of the NETBOOK PRO in environments with condensing humidity or humidity outside these limits may result in damage to the NETBOOK PRO.

## **Magnetic Fields And Static Electricity**

The magnet of the NETBOOK PRO speaker may corrupt data stored on magnetic media. Do not keep the NETBOOK PRO next to credit cards or other magnetic media.

Avoid exposing the NETBOOK PRO to strong magnetic fields or static electricity. Such exposure may cause loss of data or result in damage to the NETBOOK PRO.

## **Service**

Do not attempt to dismantle the NETBOOK PRO. There are no user-serviceable parts inside, and any attempt to dismantle the NETBOOK PRO will invalidate the warranty.



# GETTING STARTED

# 2

2.1 Features Of The NETBOOK PRO . . . . .	11
2.2 Turning On And Off . . . . .	11
2.3 Passwords . . . . .	12
2.4 Finding And Using The Stylus. . . . .	13
2.5 Power Management . . . . .	14
2.5.1 Power Properties . . . . .	15
2.5.1.1 Battery . . . . .	16
2.5.1.2 Battery Calibration . . . . .	16
2.5.1.3 Power Saving Schemes . . . . .	18
2.5.1.4 The Advanced Tab. . . . .	21
2.5.2 Battery Care . . . . .	22
2.5.2.1 Fitting The Main Battery . . . . .	22
2.5.2.2 Charging The NETBOOK PRO Battery Pack. . . . .	22
2.5.2.3 Changing Battery Packs . . . . .	22
2.5.2.4 Prolonging Battery Life . . . . .	23
2.5.2.5 The Internal Backup Battery. . . . .	24
2.6 Memory Cards . . . . .	24
2.6.1 Inserting And Removing An MMC Or SD Card . . . . .	25
2.6.2 Inserting And Removing A Compact Flash Card . . . . .	26
2.6.3 Inserting And Removing A PCMCIA Card . . . . .	27
2.7 Connecting USB Accessories . . . . .	28
2.8 The Start Button And Taskbar . . . . .	29
2.9 Resetting The NETBOOK PRO . . . . .	30
2.9.1 Performing A Soft Reset. . . . .	31
2.9.2 Performing A Hard Reset . . . . .	32

- 2.10 First Steps . . . . . 33
  - 2.10.1 Navigating Between Files And Folders. . . . . 33
  - 2.10.2 Starting Programs . . . . . 34
  - 2.10.3 Programs And Files . . . . . 34
  - 2.10.4 Entering Information . . . . . 34
  - 2.10.5 Using Menus . . . . . 34
  - 2.10.6 Using Dialogs . . . . . 35
    - 2.10.6.1 Dialog Buttons . . . . . 36
  - 2.10.7 Copying Information Between Programs . . . . . 36

## 2.1 Features Of The NETBOOK PRO

The NETBOOK PRO is a sub-notebook mobile computer using the Windows® CE.Net operating system, with an SVGA touch-sensitive screen. The NETBOOK PRO is lightweight and designed for use in a wide range of business areas including field service, field sales, transport, health care, hospitality, manufacturing and insurance.



Figure 2.1 The NETBOOK PRO

## 2.2 Turning On And Off

**To switch on:**

open the NETBOOK PRO.



**Note:** *In its default configuration, the NETBOOK PRO will wake up when the case is opened, and sleep when the case is closed. These and other power-on/power-off options can be changed on the Advanced tab of the Power Properties control panel.*

**To switch off:**

press and hold the **Fn** key, then press the **Esc/On** button to turn off the NETBOOK PRO. You can switch off at any time. You do not have to save information stored in the NETBOOK PRO's internal memory, as it is automatically saved for you. If you are working with a file on a memory card, save the file before switching off the NETBOOK PRO and removing the card.



**Note:** *If you do not use the NETBOOK PRO, it will automatically switch off after a few minutes to save battery power. To continue using the NETBOOK PRO where you left off, switch the NETBOOK PRO on again using the On/Off button. Your information will be saved as long as the backup battery retains charge. See "Power Management" on page 14 for information on checking battery-charge levels and power settings.*

## 2.3 Passwords

The NETBOOK PRO may be configured to require a password when it is turned on. To do this:

1. Select **Start, Control Panel**. The *Control Panel* appears.
2. Double-click on the Password icon. The Password Properties dialog appears:



3. Enter a new password, and enter it again to confirm it. The *Enable Password Protection* section of the dialog becomes active.
4. Select the **At Power On** checkbox to enable the power-on password.
5. Press the **OK** button. When the NETBOOK PRO is turned on, it will request the power-on password before opening the Desktop. Changes to the *Owner* and *Password* settings will also require the password.

To disable the power-on password:

1. Select **Start, Control Panel**. The *Control Panel* appears.
2. Double-click on the **Password** icon. A dialog appears, requesting the existing password.
3. Enter the existing password. The *Password Properties* dialog appears.
4. Deselect the *At Power On* checkbox.
5. Press the **OK** button.

The existing password will still be active. Any changes to the *Owner* or *Password* settings will still require this password for access.

To completely disable the password, clear the two password-entry fields and press the **OK** button. The password will not be then needed for access to the *Owner* or *Password* settings.

## 2.4 Finding And Using The Stylus

The stylus is located in the NETBOOK PRO, in a holder at the right.

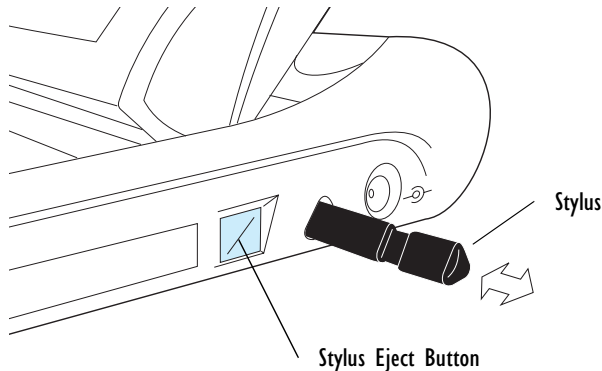

Figure 2.2 Location Of The Stylus

To remove the stylus, push the square button next to it. The stylus pops out. To replace the stylus, push it back in. You can use your fingers to tap on the screen, though it is best to use the stylus to avoid fingerprints or smudges on the screen.

**Do not** tap the screen with any object that has a sharp tip or you may damage the screen. Don't use any type of ink pen, as the ink may be impossible to remove.

See “Caring For The NETBOOK PRO” on page 5 for instructions on how to clean the screen.

You can usually tap on (“click on”) an item with the stylus to select or change it, simulating the standard mouse clicks. For example, you can:

- Single-tap (or single-click) to select an item.
- Double-tap (or double-click) a program icon, to open a program.
- Hold down the **Alt** key, then tap, to right-click. Right-click on an item to display its ‘context menu’, which gives access to the object's properties.

## 2.5 Power Management

The NETBOOK PRO is powered by a Lithium Ion rechargeable battery pack (for details, see “Battery Life Of The NETBOOK PRO” on page 102). The NETBOOK PRO can be powered from AC when used with the AC adaptor. When the NETBOOK PRO is powered from the AC adaptor, it will also charge the battery pack.



**Note:** *How long your batteries last will depend upon how you use your NETBOOK PRO. The NETBOOK PRO will use considerably more battery power when you have the brightness turned up, are using files stored on a memory card, or are using infrared or a communications card.*





*You can take steps to help prolong your battery's life:*

- *Turn the screen brightness down.*
- *Set the delay time to **10 minutes** in the Switch to Suspend option of the Battery Power scheme of the Power Schemes tab in the Power Properties control panel (see page 20).*
- *Open and use files from internal storage instead of from a memory card, as the NETBOOK PRO requires more power to write to memory cards.*



## 2.5.1 Power Properties

Power Properties for the battery can be accessed either through the *Power* icon in the Control Panel (for the Control Panel screen, see Figure 2.14 on page 30), or by double-clicking the taskbar power icon (this icon changes depending on power status, as described in Table 2.1).

System Tray Icon	Description
 Low Back-up Battery	Appears when back-up battery charge is less than 25% of capacity.
 External Power Indicator	Appears when the NETBOOK PRO is connected to the AC adaptor and the main battery is fully charged. Disappears when the AC adaptor is disconnected.
 Low Main Battery	Appears when main battery charge drops below 50% of capacity.
 Critical Main Battery	Appears when main battery charge drops below 25% of capacity.
 Charging Main Battery	Appears when the NETBOOK PRO is connected to the AC adaptor, and the battery is charging.
No Charge Icon	All charge-related icons disappear if battery levels are not low or critical, and the NETBOOK PRO is not connected to an external power source.

**Table 2.1 System Tray Icon Charge States**

### 2.5.1.1 Battery

To check the battery power status, click on the *Battery* tab:

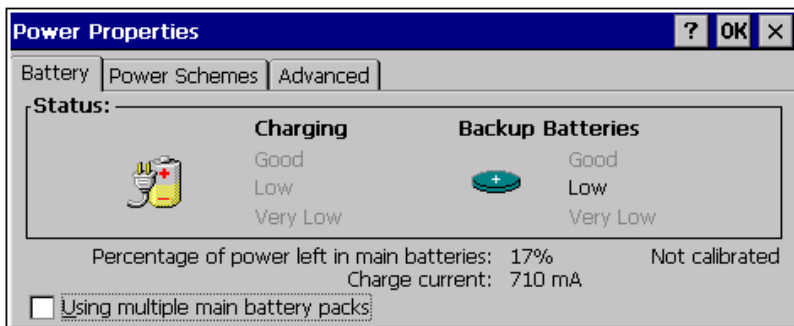

Figure 2.3 Power Properties: Battery

This tab describes the main and backup batteries, and their state. A warning message to change or recharge the battery appears when the main or backup battery levels become critically low.

This tab includes a checkbox, *Using multiple main battery packs*. When this checkbox is selected, the NETBOOK PRO calibrates each battery pack anew each time the pack is inserted. When this checkbox is not checked, the NETBOOK PRO retains the battery calibration information when the battery pack is removed. See “Battery Calibration” below for details.

This tab also displays an indication of charge or discharge current for the main battery. The user can see how the current varies as the main battery charges and discharges, the backlight is adjusted, or a peripheral card is inserted.



**Note:** *The current measurement displayed may be up to ten seconds old.*

### 2.5.1.2 Battery Calibration

The NETBOOK PRO uses ‘battery calibration’ to increase the accuracy of the remaining charge indication for its rechargeable battery.

When a battery pack is first connected, the NETBOOK PRO tracks its discharge and charge current and voltage over a full discharge/charge cycle. This enables it to form a picture of how the battery behaves, and thus give accurate estimates of how long

the charge will last during day-to-day use. An indicator beside the estimate of remaining charge in the main battery displays either 'Not calibrated', 'Calibrating', or nothing:

- When the Battery tab of the Power Properties dialog displays the 'Not calibrated' message, the NETBOOK PRO has not yet calibrated the battery.
- When it displays the 'Calibrating' message, the NETBOOK PRO is setting up its battery calibration. To do this, it tracks the performance of the battery through a complete discharge and charge cycle.

The percentage capacity estimate of the battery is not very accurate in the 'Not calibrated' state, somewhat more accurate in the 'Calibrating' state, and should be very accurate once the battery has been calibrated.



**Note:** *Psion Teklogix recommends that the battery be fully charged when first used, then fully discharged before being charged again.*

When the battery is calibrated, the 'Calibrating' indication vanishes. Once the battery is calibrated, the NETBOOK PRO continues to refine its estimate every time it sees a full charge or discharge cycle. The battery-charge indication is thus adjusted for ageing battery packs.

A calibration cycle will abort if the AC power state is changed (if the power cable is plugged in or removed). Calibration during charging can also abort if the unit gets too hot.

The 'Not calibrated' indicator will reappear, and calibration of the gauge is lost, if any of these four conditions occur:

- The unit automatically shuts off due to low battery, when the capacity estimate is greater than 6%.
- Battery charging ceases (charge current less than 100mA) and the capacity estimate is less than 94%.
- Capacity estimate reaches 0% and unit continues to run for more than 15 minutes.
- Capacity estimate reaches 100% and unit continues to charge with charge current greater than 100mA for more than 15 minutes.

### 2.5.1.3 Power Saving Schemes

The *Power Schemes* tab specifies the settings for the two ‘power schemes’ named **On AC Power**, and **On Battery Power**. These power schemes group settings to be used when the NETBOOK PRO is running on battery power or when it is connected to external power.

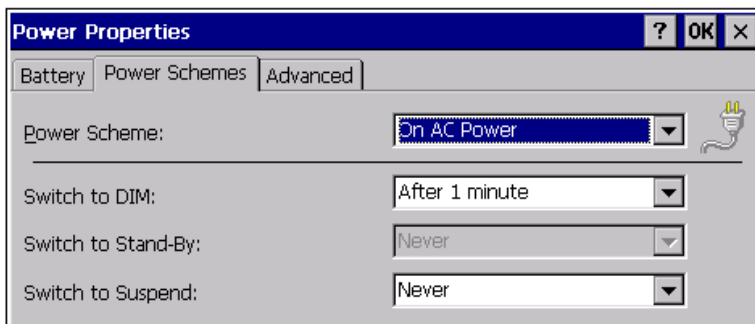

Figure 2.4 Power Properties: Schemes



**Note:** *The Power Properties Schemes settings are cumulative—that is, to determine when the NETBOOK PRO enters ‘Suspend’ state, the unit waits for the ‘Switch to Dim’ time to elapse, followed by the ‘Switch to Stand-By’ time, and then, once the ‘Switch to Suspend’ time has elapsed, ‘Suspend’ state is activated.*

When setting the *Switch to Dim*, *Switch to Stand-By*, and *Switch to Suspend* states, keep the following in mind. Because the NETBOOK PRO ‘wakes up’ from the *Dim* and *Stand-By* states almost instantaneously following any user input (button press, screen tap), the timeouts you set will not slow user activity. The sum of the *Switch to Dim*, *Switch to Stand-By*, and *Switch to Suspend* timeouts should be selected carefully since the NETBOOK PRO will go to sleep (appear off) when this time has elapsed, saving battery power.

Psion Teklogix recommends starting with a total of **10 minutes** for this overall timeout. Setting any of these timeouts to **Never** does not affect the other timeout options, but will adversely affect the battery run time. If all three timeouts are set to **Never**, the NETBOOK PRO will remain on. To further reduce power consumption, carefully consider the duration of time that the display backlight is ON or turned up (see “Backlight Properties” on page 30).

The following are the default values for the power schemes options:

Option	AC Power	Battery Power
Switch to Dim	After 1 minute	After 30 seconds
Switch to Stand-By	Never	Never
Switch to Suspend	Never	After 10 minutes

Table 2.2 Power Schemes Default Values

## Power Scheme

This dropdown menu allows you to identify whether the unit is using **AC Power** or **Battery Power**.

## Switch To Dim

During the *Dim* state the backlight brightness is turned down after the specified time has elapsed, if the NETBOOK PRO does not receive any user input, including activities such as a screen tap—any user-initiated activity. When the NETBOOK PRO enters the *Dim* state, it begins to monitor the time specified in the *Switch to Stand-By* menu.

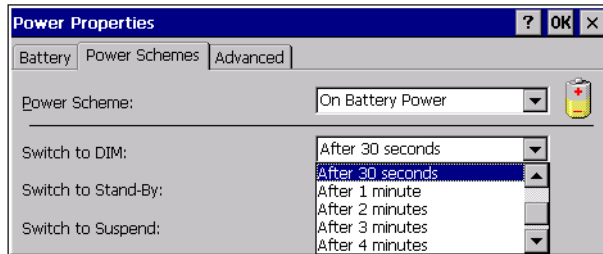

Figure 2.5 Power Schemes: Switch To Dim Menu

Press any button to bring the unit out of *Dim* state.

## Switch to Stand-By

In *Stand-By* state, the NETBOOK PRO turns off the display, but the programs and NETBOOK PRO hardware remain active. System activity includes computer activity such as serial data, an activity initiated by an application, and so on—any

activity not executed by the user. *Stand-By* is activated when the time specified in the *Switch to Stand-By* and the *Switch to Stand-By* options have elapsed without any activity. The NETBOOK PRO then begins to monitor the *Suspend* time.

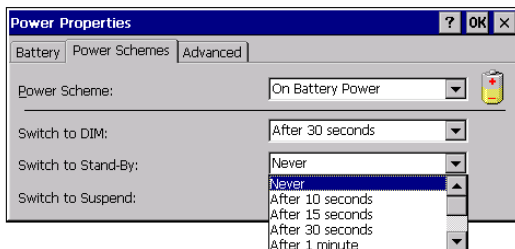

Figure 2.6 Power Schemes: Switch To Standby Menu

Press any button to bring the unit out of *Standby* state.

## Switch to Suspend

Once the time specified in the *Switch to Dim* and the *Switch to Stand-By* states have elapsed, the NETBOOK PRO begins to count down the time specified in the *Switch to Suspend* option. When the time in the *Suspend* option elapses, the unit enters *Suspend* state.

In *Suspend* state, the NETBOOK PRO CPU suspends all activity, turns off the display, and goes into a low power state. The state of the device (RAM contents) is preserved.

Select **Suspend** from the *Start Menu* or press the **Fn** and **Esc** keys together to put the NETBOOK PRO into *Suspend* state. The NETBOOK PRO may be configured to allow entry into *Suspend* state if external communications connections are active; these options can be set in the *Advanced* tab of the *Power Properties* dialog.

Press the **Esc/On** key to wake up the unit. You can also enable the unit to wake from *Suspend* when a number of external events occur, by checking the appropriate option box in the *Advanced* tab of the *Power Properties* dialog.



**Note:** *When the NETBOOK PRO is in suspend state, any network connection is broken. To resume, you must re-establish the network connection.*

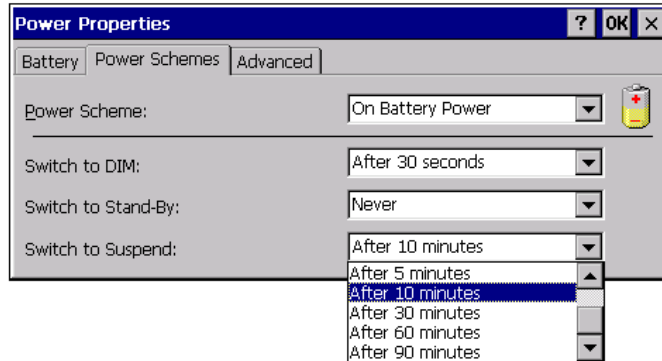

Figure 2.7 Power Schemes: Switch To Suspend Menu

### 2.5.1.4 The Advanced Tab

The Advanced tab of the Power Properties dialog contains settings that govern when the NETBOOK PRO will switch on and off:

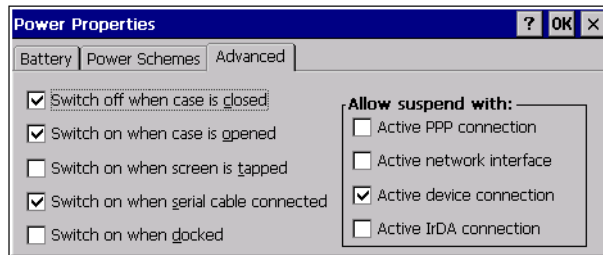

Figure 2.8 Power Properties: Advanced

The NETBOOK PRO can be configured to switch off when its case is closed, and switch on when its case is opened (these are the default settings). It can also be configured to switch on when a serial cable is connected, or when the screen is tapped.

The NETBOOK PRO can be configured to enter the *Suspend* state when it has an active PPP, network, device, or infrared (IrDA) connection. By default, it will not enter Suspend state when one of these connections is active.

## 2.5.2 Battery Care

### 2.5.2.1 Fitting The Main Battery

Before you can use the NETBOOK PRO you must fit the main battery—slide it into place, then slide the cover across until it latches into place, as shown in Figure 2.9 on page 22.



**Important:** *Always switch off the NETBOOK PRO before removing the main battery.*

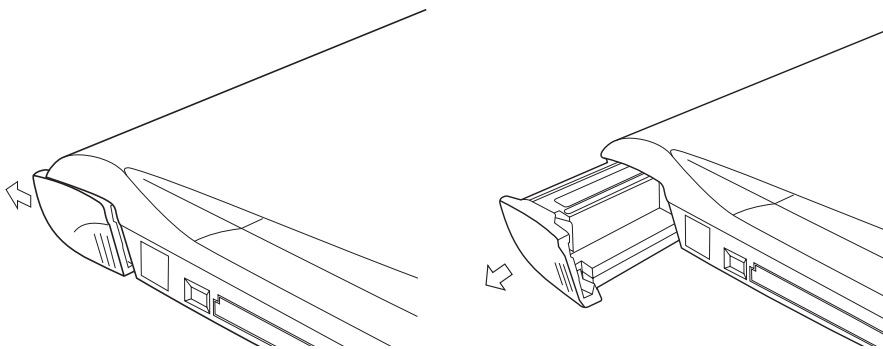

Figure 2.9 Main Battery Removal



**Important:** *Take care when replacing batteries! The NETBOOK PRO will warn you when its main battery is getting low, in plenty of time to charge it.*

### 2.5.2.2 Charging The NETBOOK PRO Battery Pack

To charge the battery, attach the battery pack to the NETBOOK PRO and connect the supplied AC adapter. The standard (2200 mA) NETBOOK PRO battery will normally be fully charged within 3 to 4 hours.

### 2.5.2.3 Changing Battery Packs

If you are using your NETBOOK PRO away from the charger and a spare battery pack is available, you can change batteries when the battery warning is displayed. To do this:



1. Switch the NETBOOK PRO off.
2. Slide the battery pack latch towards the rear of the NETBOOK PRO.
3. Pull the battery away from the NETBOOK PRO to remove it.
4. Push in the replacement battery pack.

The backup battery preserves the contents of the NETBOOK PRO.

If you are going to use more than one battery pack, you should indicate this on the Battery tab of the Power Properties dialog by selecting the check-box ‘Using multiple main battery packs’. This option indicates that any time you remove a battery, you may be replacing it with a different one. When the battery is removed, the NETBOOK PRO discards the current battery capacity information, and starts from the ‘Not calibrated’ state for the battery gauge.



***Important:*** *Always switch off the NETBOOK PRO before removing the main battery.*

#### 2.5.2.4 Prolonging Battery Life

When your NETBOOK PRO is switched off, it is in the ‘Suspend’ state and will continue to use a small amount of battery power. If you are going to leave your NETBOOK PRO switched off for a long period of time, you are advised to back up your data beforehand because the batteries will eventually run out. For details on battery usage and life, please refer to “Battery Life Of The NETBOOK PRO” on page 102.

### 2.5.2.5 The Internal Backup Battery

The NETBOOK PRO has an internal backup battery designed to retain data while the main battery pack is charging or being changed over. The backup battery is a pair of non-rechargeable alkaline AAA cells that may be changed by the user.

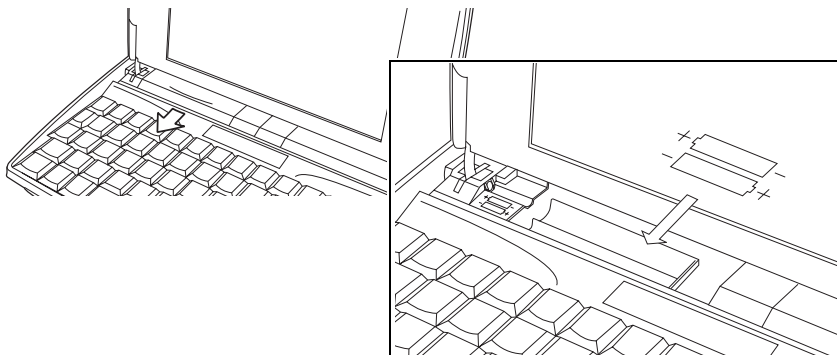

Figure 2.10 Backup Battery Insertion



**Important:** *If both the main battery pack and the backup battery are allowed to fully discharge, you will lose all your information in internal memory. However, some of your data can be protected from loss using the flash folder. Please refer to page 54 for details.*

## 2.6 Memory Cards

The NETBOOK PRO accepts non-volatile memory cards, which fit into dedicated slots in the unit and can be used to store application software and/or data. The NETBOOK PRO accepts the following types of memory cards:

- Compact Flash (CF) cards.
- MultiMedia Cards (MMCs).
- Secure Digital (SD) cards.
- PCMCIA cards.

Each memory card appears as a separate folder in the file browser. See section 4.9 on page 53.

## 2.6.1 Inserting And Removing An MMC Or SD Card

The MMC/SD slot is located on the lower front of the NETBOOK PRO (see Figure 2.11).

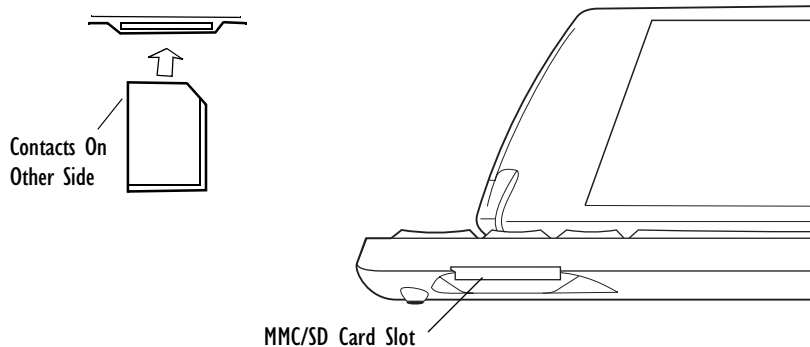

Figure 2.11 MMC/SD Slot Location

MMC cards are keyed so that they may not be inserted incorrectly (SD cards cannot be inserted incorrectly). When a memory card is inserted, a folder for it appears in the Windows Explorer file browser.

To insert a card:

- Push the MMC or SD into the slot until it clicks. It will then bounce outward slightly.



**Note:** *Always insert the MMC or SD card with the contacts first and the notch to the right.*

To remove a card:

- Push the edge of the card inwards. It will click, and then bounce out. The end may then be grasped. Pull the card outward to remove it.

Store your MMC or SD card safely.

## 2.6.2 Inserting And Removing A Compact Flash Card

The CF slot is located on the left-hand side of the NETBOOK PRO (see Figure 2.12).

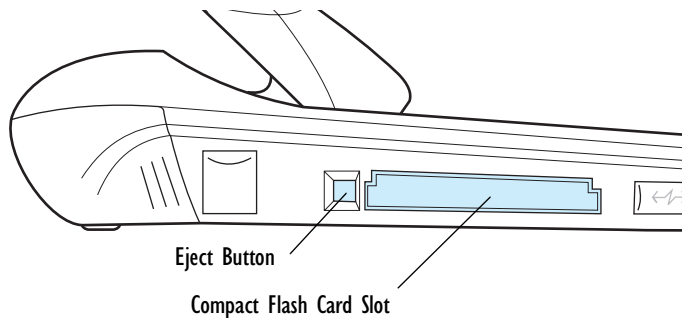

Figure 2.12 Compact Flash Slot Location

CF cards are keyed so that they may not be inserted incorrectly. When a memory card is inserted, a folder for it appears in the Windows Explorer file browser.



**Note:** *The CF eject button must first be pressed in and released so that the button pops out. Then the button can be pressed in to pop the card out.*

To insert a CF card:

- Push the Compact Flash card into the card slot on the left-hand side of the NETBOOK PRO.

To remove a CF card:

- Press the eject button next to the slot inwards. The card pops outward, and can then be pulled outwards.

Store your Compact Flash card safely.

## 2.6.3 Inserting And Removing A PCMCIA Card

The PCMCIA card slot is located on the right-hand side of the NETBOOK PRO (see Figure 2.13).

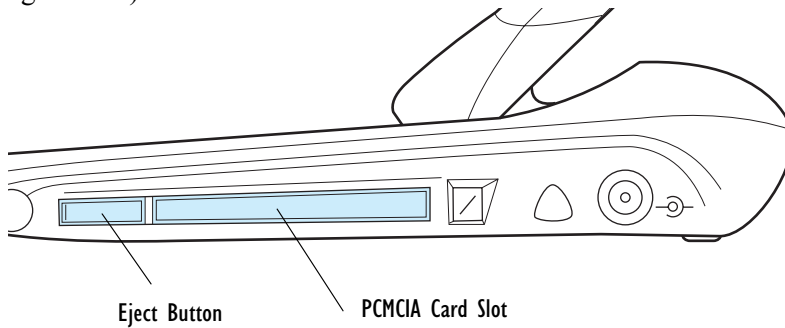

Figure 2.13 PCMCIA Slot Location

PCMCIA cards are keyed so that they may not be inserted incorrectly. When a memory card is inserted, a folder for it appears in the Windows Explorer file browser.

To insert a PCMCIA card:

- Push the card into the card slot until it clicks. The eject button next to the card slot pops out.



**Note:** *The Eject button may be folded back against the side of the NETBOOK PRO when a PCMCIA card is inserted.*

To remove a card:

- Press the eject button next to the slot inwards. The card pops loose, and can then be pulled outwards.

Store your PCMCIA card safely.

## 2.7 Connecting USB Accessories

The NETBOOK PRO can accept USB accessories, such as a mouse or printer. The NETBOOK PRO's USB connector is located at the lower left of the device:

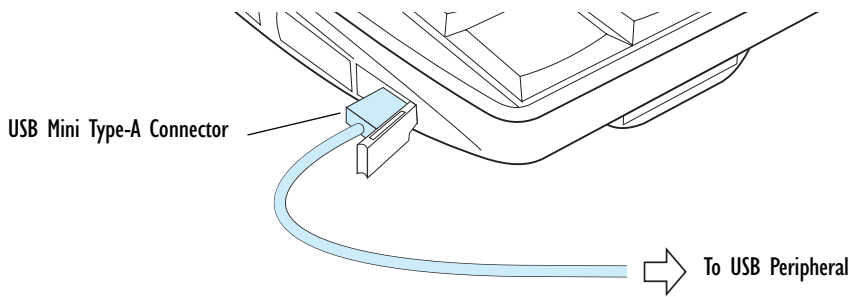

**To connect:**

plug the accessory into the USB port. The NETBOOK PRO will search the USB interface for the device and display a dialog that it has been found.



**Note:** *If the connected accessory requires drivers, they must be loaded through ActiveSync or from a memory card before the accessory is connected.*

## 2.8 The Start Button And Taskbar

By default, the NETBOOK PRO screen has a ‘taskbar’ across the lower edge of the display. At the left of the taskbar is a ‘Start button’, which gives easy access to the programs in the device.



### ***Start Menu:***

The Start menu provides convenient access to the NETBOOK PRO’s programs and settings. Display it by clicking on the *Start* button:

### The Control Panel:

The Control Panel contains settings for various system features of the NETBOOK PRO. It is accessible by selecting *Start, Settings, Control Panel*:

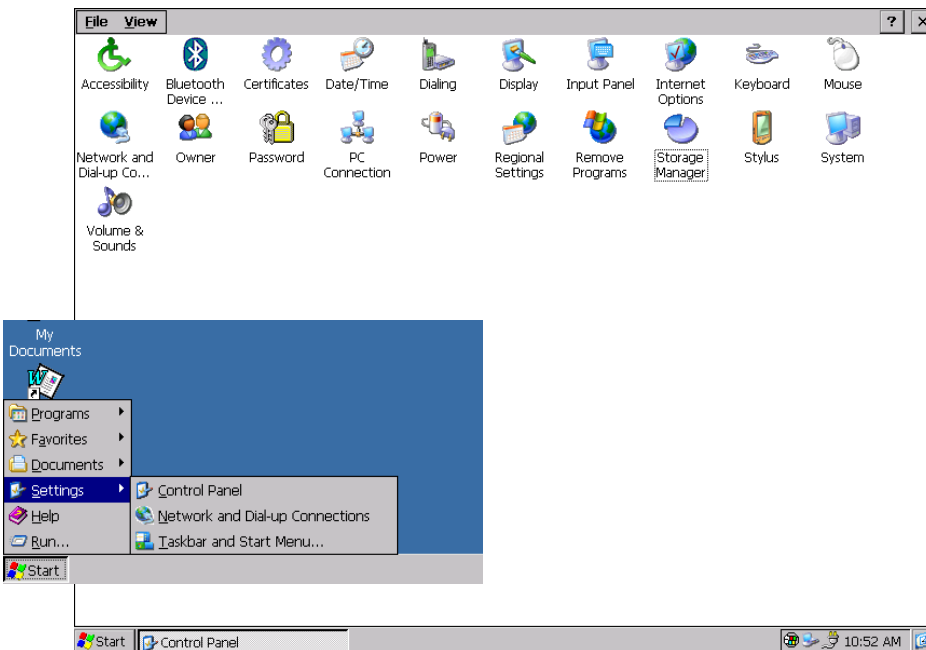

Figure 2.14 Control Panel

## 2.9 Resetting The NETBOOK PRO

If you find that you can't exit a program normally, you can end the program from the *Task Manager*.

To open the *Task Manager*, perform one of the following:

- Press the **Alt** and **Tab** keys simultaneously.
- Press the **Ctrl**, **Alt**, and **Delete** keys simultaneously for less than three seconds:

The *Task Manager* appears. Select the task that appears to be unresponsive and click on the **End Task** button.



If this does not work, or your NETBOOK PRO appears to have ‘locked up’, you can perform a ‘soft reset’. This should restart your NETBOOK PRO while preserving most of your information. After a soft reset, any changes to open files will be lost. Files in internal flash storage are preserved.

It is worth trying a soft reset if the keys on the NETBOOK PRO do not appear to respond, or if the NETBOOK PRO appears to switch on and you are sure that the batteries are good, but the screen is otherwise blank.

It is possible, though unlikely, that performing a soft reset after a program failure would cause the NETBOOK PRO to lose the information in its internal flash storage; it could even prevent the reset from working at all. If this happens, you will have to perform a ‘hard reset’. This will erase all data in internal storage.



**Important:** *A hard reset resets the NETBOOK PRO completely. All running programs, unsaved information, or programs installed to the RAM disk will be lost.*

*Anything saved to non-volatile (flash disk) storage will be preserved. Any registry settings that have been written to non-volatile storage will be preserved.*

## 2.9.1 Performing A Soft Reset

To perform a soft reset:

1. Do one of the following:
  - Execute the ‘warmboot.exe’ program found in the Windows folder.
  - Hold down the **Ctrl**, **Alt**, and **Delete** keys for three seconds.

- Gently press a thin object, such as an unfolded paper clip, onto the **Reset** button. This is located in a hole to the right of the righthand **Shift** key (see Figure 2.15 below). Hold the reset switch down for a second.

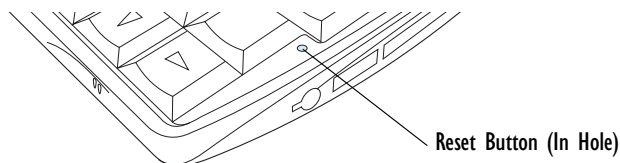

**Figure 2.15 Reset Button Location**

If the NETBOOK PRO turns off:

2. Press the **On/Off** button to turn the NETBOOK PRO back on.



**Note:** *Pressing the **On/Off** button is only necessary if the unit has been reset through use of the reset switch.*

After a soft reset, any changes to open files will be lost. Your other files in internal storage will almost always be safe. When you use the warmboot.exe program, changes made to the registry will be saved.

## 2.9.2 Performing A Hard Reset

To perform a hard reset:

- Remove all batteries and AC power.



**Notes:**

1. *When performing a hard reset, it is a good idea to remove the backup batteries before the main battery, to avoid unnecessary drain of the backup batteries.*
2. *Hard resetting the NETBOOK PRO will delete the ActiveSync partnership on the NETBOOK PRO. You may delete and recreate the partnership on the PC, or create another partnership with a new name. Refer to ActiveSync's online help for more detail on this operation.*

## 2.10 First Steps

When you first switch on the NETBOOK PRO, you will see the Windows CE desktop. At this time it is a good idea to set the date and time. To do this:

1. Press the *Start* button. Select *Settings, Control Panel*. The Windows *Control Panel* opens.
2. Double-tap on *Date/Time Properties*. The *Date/Time Properties* dialog appears.
3. Set the desired date and time values.
4. Click the *OK* button in the *Date/Time Properties* dialog to close and save your changes.



**Note:** You can also double tap the time indication in the taskbar to open the *Date/Time Properties* dialog.

### 2.10.1 Navigating Between Files And Folders

- Double-click on a folder icon to open that folder. To close the folder, click on the **X** icon at the far right of the menu bar. Click on the **Up Folder** icon to move back up one level.
- Click on a file to select it. Double-click to open it.

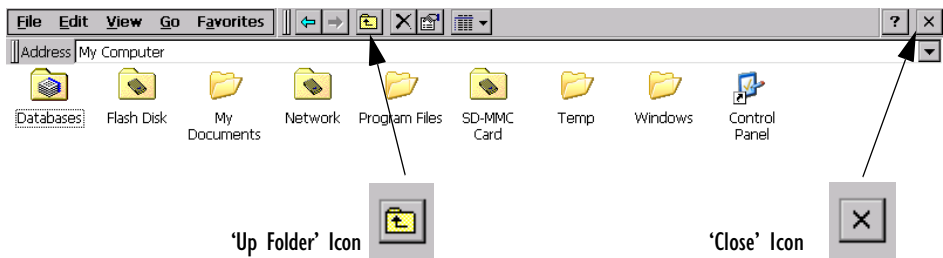

## 2.10.2 Starting Programs

When you open a file, the correct program for this file is started automatically. You can also start programs by clicking on them from the *Start Menu*. You don't have to close one program before opening another. The taskbar displays all open applications.



## 2.10.3 Programs And Files

**To create a new file:**

open the program, select the **New** command on the *File* menu and type in the name for the new file (see “Entering Information”, below). The file will now be created. You can start entering your information. It is a good idea to keep related files together in a folder, to make the files easier to find later.

## 2.10.4 Entering Information

You can enter information and complete tasks using the stylus or the keyboard.

## 2.10.5 Using Menus

You can usually select a menu command to perform tasks.

- Click on the menu you want to access from the menu bar.
- Click on the menu names and commands, or use the arrow keys to move around the menus. Click on commands marked with a  or press the **right arrow** key to see further commands.

A menu command with three dots at the end means that selecting the command will display a “dialog” where you enter more information (see “Using Dialogs” on page 35).

If a menu command is grey, it means that it's not currently available; for example, you cannot *Copy* unless you have first selected something to copy.

## 2.10.6 Using Dialogs

A “dialog” appears when you need to make selections and enter further information. You can move between dialog items by clicking on them, or by pressing the **Tab** or **Shift + Tab** keys. The selected item is highlighted.

Dialogs contain one or more of the following elements:

***Textbox:***

where you just type in your information.

***Dropdown:***

where you select from a number of options. The current selection in the list is highlighted. You can change the selection by tapping on the arrow next to the list; the list drops down so that you may choose one of the options. You may also select options by pressing the arrow keys or by typing the first letter of the option you want.

***Checkbox:***

where you make a choice between selecting an option or not selecting it. Tap on the checkbox, or press the **Space** key, to add or remove a checkmark.

***Radio buttons:***

where you make one choice from a number of options. Just tap on an option, or use the **Left arrow** and **Right Arrow** keys to make a selection. Press the **Tab** key to leave the set of radio buttons and go on to the next item.

If an item is grey, it is currently not available. For example, if you are not connecting to the Internet through a proxy server, the *Bypass proxy server for local addresses* checkbox in *Internet Settings, Connection* tab, will be greyed out. Some dialogs comprise a number of “pages”; each page has a “tab” at the top (see Figure 2.16 on page 36). Tap on the tab, or move the highlight to the tab name, to go to that page. You can also move a dialog around the screen by holding the stylus on the dialog title bar and dragging it across the screen.

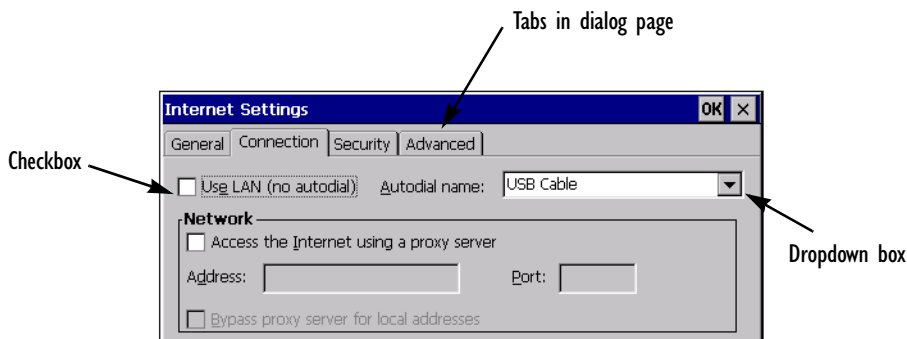

Figure 2.16 Dialog Pages

### 2.10.6.1 Dialog Buttons

Dialogs usually include standard buttons such as **Ok** and **X**. Some buttons have a standard keypress equivalent:

- Usually, you can click on the **OK** button or press the **Enter** key if you want to save information and remove the dialog.
- Click on the **Cancel** button, the **X** button, or press the **Esc** key if you want to close the dialog without saving the information.
- For dialogs that ask a question, you can click on the **Yes** button or press the **Y** key for 'yes'. Click on the **No** button, press the **N** key, or press the **Esc** key for 'no'.

### 2.10.7 Copying Information Between Programs

You can insert information created in one program into a different program. For example, you may want to compose text in Wordpad before copying it into an e-mail message in the Inbox. If you try to insert an object into a program that is not designed to handle that type of object, you will be unable to Paste. Trying to copy a file from Windows Explorer into a Wordpad document will not work because Wordpad will keep the Paste option greyed out until it detects that text is ready to be pasted.

# CONFIGURING THE UNIT

# 3

3.1 Things To Do First . . . . .	39
3.1.1 Entering Owner and Password Information . . . . .	39
3.1.2 Setting The Time, Date, And Time Zone . . . . .	39
3.2 Things To Do Next. . . . .	40
3.2.1 Setting Up ActiveSync. . . . .	40
3.2.1.1 Partnerships . . . . .	40
3.2.1.2 Connecting Via RS232 Serial . . . . .	41
3.2.1.3 Connecting Via Infrared (IrDA) . . . . .	42
3.2.1.4 Connecting Via Ethernet (802.11b) . . . . .	42
3.2.2 Backing Up To A PC. . . . .	43
3.2.2.1 Backing Up To A Memory Card . . . . .	43
3.2.3 Exploring The Control Panel . . . . .	44
3.2.4 Securing Your Information. . . . .	45





## 3.1 Things To Do First

This section describes what you may need to do to set up your NETBOOK PRO:

- Enter owner information in the Owner control panel, so that your NETBOOK PRO can be returned if you lose it.
- Set a password for your machine, so that other people cannot access your information.
- Set the current time and date.

### 3.1.1 Entering Owner and Password Information

It is a good idea to enter “owner information”, so that if the NETBOOK PRO is lost, it can be returned when found:

1. Select the **Owner** icon from the Control Panel. Fill in the fields on the Identification tab. Click **OK** to save your information.
2. Select the **Password** icon from the Control Panel. Enter a password in the first textbox and confirm it by typing it again in the second textbox. The text will be displayed as an asterisk (\*) for security.
3. Click **At Power On** if you want to display the password request screen when switching the machine on after a suspend.
4. Click **OK** to save your changes.



**Note:** *The system password does not protect files stored on memory cards or files copied to other machines. However, when connecting via ActiveSync to a unit that is password protected, you will be asked to enter the unit's password on the PC.*



**Important:** *Don't forget your password! If you have forgotten the system password then you will have to reset the machine.*

### 3.1.2 Setting The Time, Date, And Time Zone

1. In the Control Panel, open the **Date/Time** icon. The *Date/Time Properties* dialog is also accessible by double-clicking on the system time in the system tray.

## Things To Do Next

### Setting Up ActiveSync

2. You will see a dialog in which you can set the time, date, and time zone. Move the highlight in the date box by tapping on the correct date. Use the arrow buttons to change month and year. In the **Current Time** box, type in the time or use the up and down arrows to set the time.
3. Click on the **OK** button and the time and date are saved.

## 3.2 Things To Do Next

This section gives a brief overview of what else you may want to do when you first use your NETBOOK PRO.

### 3.2.1 Setting Up ActiveSync

ActiveSync allows you to connect the NETBOOK PRO to a PC serially, or through infrared or radio communication. File transfers, file synchronization and sending e-mail can all be done via ActiveSync.

ActiveSync **must** be connected through serial or infrared at least once before other connection types (Bluetooth, Ethernet, 802.11) are possible.

Install the most recent version of ActiveSync on your PC (check the Microsoft website for the latest software).

#### 3.2.1.1 Partnerships

There are two types of connection provided for by ActiveSync:

- **Guest** - A guest connection allows file transfers. No synchronization is performed. If the NETBOOK PRO is password protected, the password prompt will appear when connecting as guest.
- **Partnership** - A partnership connection allows for synchronization of files, e-mail and other data. If the NETBOOK PRO is password protected, a password prompt will appear before allowing synchronization. *It is necessary to establish a partnership before trying to connect to ActiveSync via Ethernet, Bluetooth, or 802.11.*

You can disconnect any ActiveSync connection by double-clicking on the blue icon in the NETBOOK PRO's system tray and selecting the **Disconnect** button from the dialog.

### 3.2.1.2 Connecting Via RS232 Serial

To connect using ActiveSync via RS232 serial:

1. Connect the NETBOOK PRO ActiveSync serial cable to the serial communications port on your computer (usually COM1 or COM2).
2. Connect the other end of the serial cable to the NETBOOK PRO serial port. The port is behind the rubber cover on the left hand side of the unit (labelled with the  RS232 symbol).

*On the NETBOOK PRO...*

3. Open the NETBOOK PRO's Control Panel.
4. Double-click on the **PC Connection** icon. The PC Connection dialog opens.
5. Verify that the **Use Connection** checkbox is checked and that the unit will connect using 'Serial Cable on Com 1'.

*On the PC...*

6. Select File, Connection Settings in the ActiveSync window, or double-click on the ActiveSync icon in the system tray. The ActiveSync menu appears.
7. Select Connection Settings. The Connection Settings dialog appears.
8. Place a checkmark in the checkbox labeled 'Allow serial cable or infrared connection to this COM port:'.
9. Select the COM port to which you connected the cable in Step 1.
10. Press **OK**. The Settings dialog disappears.
11. Select **File, Get Connected**. The Get Connected wizard appears.
12. Press **Next**. ActiveSync searches for a connection.

*On the NETBOOK PRO...*

13. Click on the **Start** button, then **Programs**, then **ActiveSync**, and select **direct** from the ActiveSync menu. A dialog appears, indicating that the NETBOOK PRO is attempting to connect.

## Things To Do Next

### Connecting Via Infrared (IrDA)

14. A successful connection is indicated by a blue icon  in the NETBOOK PRO's system tray. The NETBOOK PRO and the PC will also play sounds to indicate that they are connected, if sound is enabled on the devices.

#### 3.2.1.3 Connecting Via Infrared (IrDA)

To connect using ActiveSync via infrared, a partnership must already be established between the PC and the NETBOOK PRO (see “Creating The Partnership” on page 70).

1. On the PC, open ActiveSync and go to the **Connection Settings** screen. The first checkbox concerns both serial and IrDA connections. Set the dropdown to use the Infrared connection. The NETBOOK PRO supports Fast IrDA.
2. On the NETBOOK PRO, go into Control Panel and open **PC Connection**. Make sure the checkbox is checked. Make sure it will connect using the Infrared Port. If this is not the case, click on the **Change** button and set the dropdown to the correct connection type.
3. Align the IrDA port on the NETBOOK PRO with the IrDA port on the PC. Infrared requires a clear path between ports. Make sure nothing is blocking the Infrared ports.
4. On the NETBOOK PRO, click on the **Start** button, then **Programs**, then **ActiveSync**, and select **direct** from the ActiveSync menu.

#### 3.2.1.4 Connecting Via Ethernet (802.11b)

To connect using ActiveSync via Ethernet, a partnership must already be established between the PC and the NETBOOK PRO.

1. On the PC, open ActiveSync and look at the **Connection Settings** screen. Uncheck all checkboxes except *Ethernet*.
2. On the NETBOOK PRO, go into Control Panel. Open **Network and Dial-up Connections**. Open the **Properties** for the network connection by double-clicking on the icon.

3. Click on the **Name Servers** tab and fill in the **WINS** information. If your network does not have a WINS server, you must set this information to use the IP of your PC. If you do not know this information, please contact your system administrator.
4. Click on **OK** to save the network settings.
5. On the NETBOOK PRO, click on the **Start** button, then **Programs**, then **ActiveSync**, and select **wireless** from the ActiveSync menu.



**Important:** *You must have a correctly configured access point to use 802.11b Ethernet to access your PC via ActiveSync. The PC and the NETBOOK PRO must be on the same network, or networks that have access to each other, for this to function correctly.*

## 3.2.2 Backing Up To A PC

You can use ActiveSync to back up individual files, folders, or the NETBOOK PRO's entire internal storage to the PC. It is possible to configure ActiveSync to automatically back up the NETBOOK PRO every time it synchronizes.

### 3.2.2.1 Backing Up To A Memory Card

You can back up individual files, individual folders or groups of files and folders to a MultiMedia, Secure Digital, Compact Flash, or PCMCIA card fitted in the appropriate slot. To back up the files and folders, copy them from the internal disk to the card using the *Copy* and *Paste* commands in the System screen.

1. Select the files and folders you want to back up.
2. Choose the **Copy** command from the *Edit* menu.
3. Select the folder of the memory card.
4. Choose the **Paste** command from the *Edit* menu.

### 3.2.2.2 Restoring Files From A Memory-Card Backup

To restore the files and folders on a memory card to your NETBOOK PRO, they may be copied them from the memory card to internal storage in the same way as when they were backed up. To do this:

1. Select the folder of the memory card.
2. Choose the **Copy** command from the *Edit* menu.

3. Select a folder on the NETBOOK PRO as a destination.
4. Choose the **Paste** command from the *Edit* menu.

### 3.2.3 Exploring The Control Panel

*To display the Control panel:*

select the *Start, Settings, Control Panel* menu. The Control Panel opens.

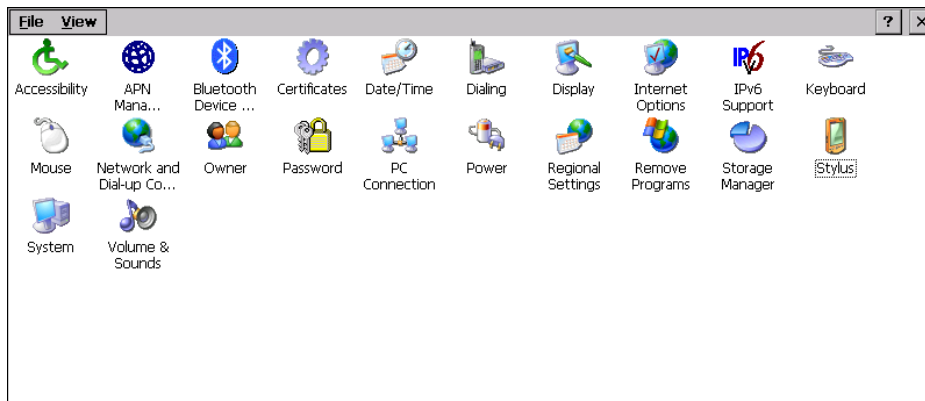

Initially, *Date/Time* should already be set, and possibly *Password* and *PC Connections* as well. You may wish to change other settings later.

Some of the other options include:

- **Regional Settings**, to change settings that may vary from country to country, such as the currency and date formats.
- **Power**, to control how and when the NETBOOK PRO switches on and off. For example, you might like it to switch on when you tap the screen, and off when you haven't used it for three minutes.
- **Display Properties**, to set the appearance of the desktop and the windows on it, and the brightness of the backlight.
- **Volume & Sound**, to control the sounds that the NETBOOK PRO makes when you press navigation keys, tap the screen and perform other actions.
- **Stylus**, to set the accuracy needed for two taps of the touch-screen to register as a 'double-tap', and also to calibrate the touch-screen.

## 3.2.4 Securing Your Information

There are no known problems with passing the NETBOOK PRO through airport security machines and other X-rays.

There are several things that you can do to secure your files against other hazards.

- To prevent accidental alterations to the contents of a file, the file can be made “read-only”. For more information see Chapter 4: “Files, Folders, and Programs”.
- To prevent accidental loss of data, files should be backed up regularly (see “Backing Up To A Memory Card” on page 43), in case they become corrupted or are deleted accidentally.
- To prevent unauthorized access to sensitive information, a password can be set to restrict access to data files.
- Enter owner information so that the NETBOOK PRO can be returned if it is lost. See “Entering Owner and Password Information” on page 39.



**Note:** *It is not possible for anyone to copy information from or to your machine using Infrared, unless they are able to access the Infrared ‘Send’ and ‘Receive’ commands on the NETBOOK PRO.*





# FILES, FOLDERS, AND PROGRAMS

# 4

4.1 Introduction . . . . .	49
4.2 Moving Around . . . . .	49
4.3 Opening Files, Folders And Programs. . . . .	49
4.4 Closing Programs/Files . . . . .	50
4.5 Creating New Folders . . . . .	50
4.5.1 Creating New Files. . . . .	51
4.6 Start Menu - Documents . . . . .	51
4.7 Changing File Attributes. . . . .	51
4.8 Managing Folders . . . . .	52
4.10 The Flash Folder . . . . .	54
4.12 The Storage Manager. . . . .	56
4.11 Checking System Memory Use. . . . .	55
4.11.1 What Happens When System Memory Is Full? . . . . .	55
4.11.2 Additional Memory And Programs. . . . .	55



## 4.1 Introduction

Windows<sup>®</sup> Explorer is the NETBOOK PRO's file manager. It is accessible by double-clicking on the **My Computer** icon.



**Note:** *When you turn the NETBOOK PRO on from a suspend, the programs that were previously open will still be open and will be displayed on the screen. When you turn on the NETBOOK PRO from a cold or warm boot, you will see the Desktop.*

## 4.2 Moving Around

**To move the highlight between the files and folders on the screen:**

click on the names, or use the arrow keys. If there are more files in the folder than can be displayed on screen, scroll the screen using the scroll bar.

**To view the files on a memory card:**

change the current folder by opening the *My Computer* folder and selecting the appropriate memory card icon.

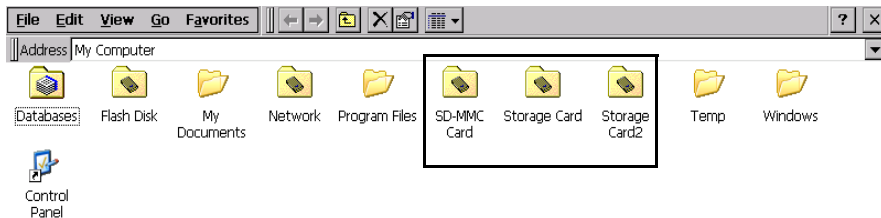

## 4.3 Opening Files, Folders And Programs

**To open a file or folder in Windows Explorer:**

double-click, or highlight it and press **Enter**. In most cases, if a program is already running, opening a file associated with that program will open another instance of that program.

**To run a program:**

Open the *Start Menu* by clicking on the **Start** button in the bottom left corner of the screen. Click on **Programs** to display all the programs available. Click on the name of the program you wish to run.

## How can I see which programs are open?

The taskbar across the bottom of the screen displays buttons for programs that are open. To switch between programs, click on the button in the taskbar.

The Task Manager displays a list of programs that are open. To open the Task Manager, press **Ctrl Alt Del** or **Alt Tab**.

## 4.4 Closing Programs/Files

### To close the current folder:

click on the **X** icon at the top left corner of the screen. When you close all open folders, you will see the Desktop.

### To close a file:

use the **Close** command on the *File* menu, in the program in which the file is open. You will be prompted to save your changes.

You can also close files or programs by selecting the list of open files and programs by using the **X** button in the upper right corner of any window.

## 4.5 Creating New Folders

New folders (or directories) can be created anywhere in the NETBOOK PRO's system.

A convenient place to keep the user documents is the *My Documents* folder under *My Computer*. It is possible to create folders inside My Documents, in which to store all your files to prevent the My Documents screen from becoming too full.

Folders can also be created in the flash disk folder or on memory cards. The contents of these folders will not be lost during a hard reset.

To create a new folder:

1. Move to the folder in which you wish to create the new folder.
2. Select the **New folder** command from the *File* menu, and type in the folder name. You can also right-click on the blank space in a folder and select **New folder** from the context menu.

You cannot use the following characters in a folder name: < > : / \ \* ?

If you use NETBOOK PRO files with a PC, you may wish to create folders that match equivalent folders on your PC. This will make transferring files between the NETBOOK PRO and PC easier.

## 4.5.1 Creating New Files

You can create files from within programs. As a general rule, open the program in which you want to create the file, and select **New** from the *File* menu. A file name is suggested. If you do not wish to use this, type a name of your own before pressing the **OK** button.

### What names can I use for my files & folders?

You can use most characters in file and folder names including spaces, for example, “2002 Purchase Orders and Invoices”. The only characters which cannot be used in a file or folder name are: / < > : \ \* ?

You may encounter difficulties if you use very long file names for files stored in folders with long names, which are nested within other folders with long names, and so on. If you do exceed the maximum allowed length, rename a folder or file to a shorter name.

## 4.6 Start Menu - Documents

A quick way to find a file that has been recently used is to look in the *Documents* menu on the *Start* menu. The Documents menu will list up to ten of the most recent files opened.

## 4.7 Changing File Attributes

You can prevent a file from being accidentally changed by making it a “read-only” file. To do this, right-click on the file and select **Properties** from the context menu. Then check the **Read-only** box.

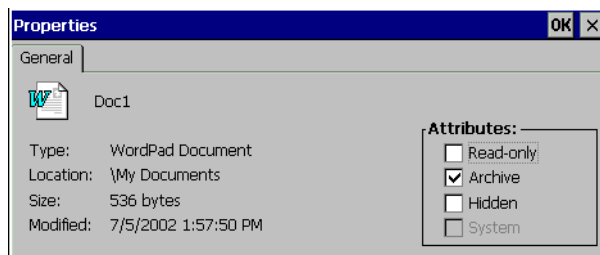

## Managing Folders

Files that have been created on a PC and then transferred to the NETBOOK PRO will also be “read-only” files.



**Note:** *If you transfer a “read-only” file to another machine, it can be viewed, and the “read-only” attribute can be removed.*

## 4.8 Managing Folders

To move one or more folders or files from one location to another:

1. First highlight the file(s) or folder(s) to select them. Drag with the stylus to select more than one file.

To select all the files/folders in the current folder, use the **Select all** command on the *Edit* menu. To deselect items, press the **Esc** key.

2. Select the **Cut** command from the *Edit* menu. A dotted line appears around the file/folder icon(s).
3. Go to the folder into which the highlighted items are to be moved.
4. Select the **Paste** command from the *Edit* menu.



**Note:** *Moving a folder also moves all the files within that folder.*

**To copy a file or folder, or multiple files/folders to a different folder:**

follow the earlier instructions, but select the **Copy** as opposed to the *Cut* command from the *Edit* menu.

**To make a copy of a file or folder within the same folder:**

highlight it and select the **Copy** command followed by the **Paste** command. A new file is automatically created for you using the following naming convention (with Wordpad as the example): Copy of Doc1, etc. You can rename the file or folder later if you wish.

**To rename a single file or folder:**

right-click, select **Rename** from the context menu, and then type in a new name.

**To remove one or more files or folders:**

first highlight them and then either press the **Delete** key, or select the **Delete** command from the *File* menu. You can also right-click and select **Delete**.



**Important:** *If you are deleting folders, remember that the entire contents of the folders (including all the other folders contained within them and all their files) will also be deleted.*

## 4.9 Memory-Card Folders

Each memory card appears as a separate folder in My Computer.

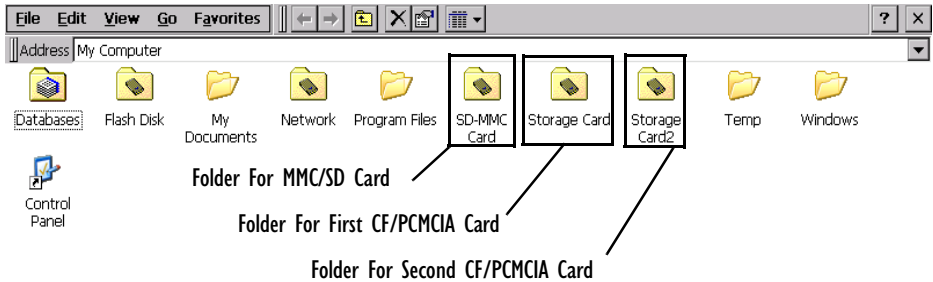

The MMC/SD card has folder name 'MMC Card'. In the Storage Manager, it has device name 'SMC1:' (see section 4.12 on page 56 for details about the Storage Manager).

CompactFlash and PCMCIA cards are treated identically by the system. Whichever of them is inserted first is assigned folder name 'Storage Card' and device name 'DSK2:'. Whichever is inserted second is assigned folder name 'Storage Card2' and device name 'DSK3:'. These folder and device names remain constant while the cards are connected (if one is removed, the names for the other do not change), but if both the CF and PCMCIA cards are removed and replaced in reverse order, the designations will be swapped.



**Note:** *This assumes that there is only one partition on each card.*

## 4.10 The Flash Folder

The Flash folder, accessed from the *My Computer* icon on the desktop, can be used both to store data securely in case of power loss, and to install *.cab* (cabinet) files.

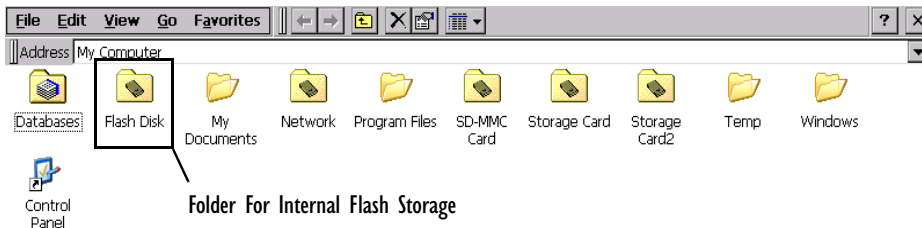

Data stored in this directory will still exist even if the main battery and backup battery are discharged. Data will also remain in this directory after a “soft” or “hard” reset. The size of storage is limited—to see the amount of space available in this folder, right-click on the **Flash** icon in *My Computer*, and select **Properties** in the dropdown menu.

The Flash folder can also be used to store *.cab* files that you want installed automatically following a cold boot. Place any *.cab* files you want installed into the Flash folder named **Auto Restore**. If there are some files you don’t want installed automatically with a cold boot but want to keep secure, either back those up to your PC or place in another folder within the Flash folder.

The Flash folder has device name ‘DSK1:’ in the Storage Manager.



## 4.11 Checking System Memory Use

**To display the amount of system memory (RAM) remaining:**

double-click the **System** icon in the Control Panel and select the **Memory** tab. You can see the amount of free memory in the slider bar.

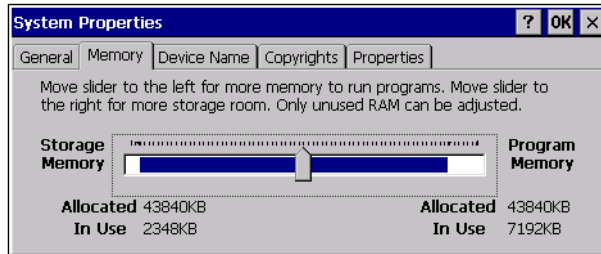

### 4.11.1 What Happens When System Memory Is Full?

When the system memory is nearly full, you will see warning dialogs when running programs to indicate that the NETBOOK PRO's memory is almost full, and there is not enough memory to perform some tasks. Many actions need just a little free memory in order to work—displaying dialogs, menus, etc. These can fail with a message like 'Memory full'. The NETBOOK PRO will not allow you to use all of the available memory; it will always set aside enough memory for you to close a program or save an open file to a multimedia card.

Files saved on the internal flash memory, files saved on memory cards, and 'open' programs do not use system memory.

Applications running from RAM, or files stored outside the Flash folder or memory cards, do use system memory. To free memory, close these files, delete any unwanted files, or move files to a multimedia card or your PC.

### 4.11.2 Additional Memory And Programs

You can insert memory cards into the slots of the NETBOOK PRO. You might use them as additional memory for storing files, or to add more programs to the NETBOOK PRO. For details, please refer to "Memory Cards" on page 24.

**If a memory card contains additional programs:**

their icons will be available in the card's folder.

## 4.12 The Storage Manager

Double-click on the Storage Manager icon to open the Storage Manager dialog:

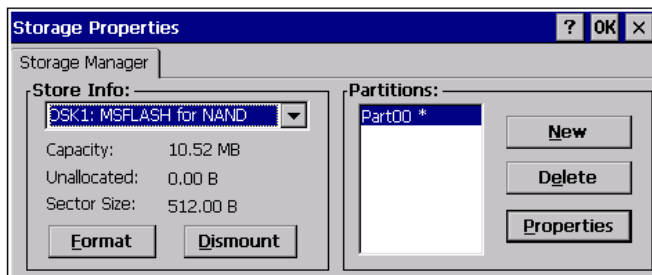

The Storage Manager allows the user to view information about the storage devices that are present in the NETBOOK PRO. Storage devices include MMC/SD flash cards, PCMCIA flash cards and microdrives, and CompactFlash cards and microdrives.

### 4.12.1 Formatting A Memory Card

Formatting a memory card bulk-erases it. Once a card is erased, partitions may be created in it, similarly to those on a hard drive.

Memory-card devices are normally 'mounted' (made available to the system) automatically when they are inserted. They must be dismounted before they can be formatted.

To format an entire memory card:

1. Select *Start, Control Panel*.
2. Double-click on the Storage Manager icon. The Storage Manager opens:

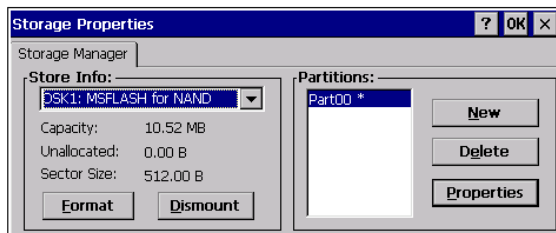

3. Select the memory card from the drop-down list.
4. Press the **Dismount** button to dismount the memory card. All partitions on the card will be dismounted.
5. Press the **Format** button to format the memory card.



**Warning:** *All partitions and information on the card will be erased during the formatting process.*

## 4.12.2 Creating Partitions

Once the card is formatted, new partitions can be created in it. The default is to create one partition that occupies the whole card, but a card can be divided into more than one partition if desired. Each partition appears as a separate folder in Windows Explorer.

To create new partitions:

1. Press the New button next to the Partitions listbox. The New Partition dialog appears:



2. Enter a name for the partition.

### Creating Partitions

3. If more than one partition is desired, uncheck the *Use All Available Disk Space* checkbox, then specify the desired number of sectors to be used by the partition:

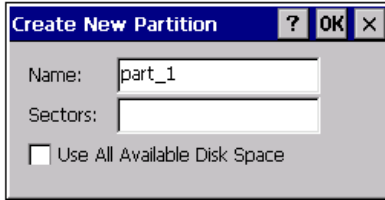

**Note:** The sector size of the card is given on the left-hand side of the Storage Properties dialog.

4. Press **OK**. The new partition appears in the Partitions list:

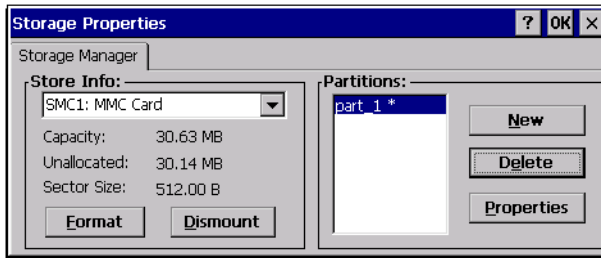

The new partition is automatically mounted. This is indicated by an asterisk (\*) next to its name in the partition list. Any unallocated space on the card is indicated at the left, and additional partitions can be created in it.

## 4.12.3 Partition Management

Partitions can be individually dismounted, mounted, deleted, or formatted as well. These and additional tasks are available from the Partition Properties dialog:

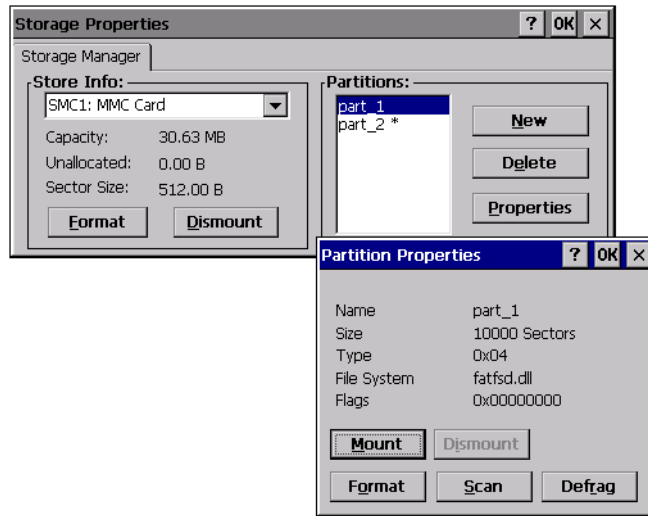

To dismount a partition:

1. Select the desired partition.
2. Press the **Properties** button. The Partition Properties dialog appears.
3. Press the **Dismount** button. The partition is dismounted. The asterisk disappears next to its name in the partitions list.

To delete a partition:

1. Select the desired partition.
2. Press the **Delete** button. A warning dialog appears.
3. Press the **OK** button. The partition is deleted.

To format a partition:

1. Select the desired partition.

## Partition Management

2. Press the **Properties** button. The Partition Properties dialog appears.
3. Press the **Dismount** button. The partition is dismounted. The asterisk disappears next to its name in the partitions list.
4. Press the **Format** button. The Format dialog appears:

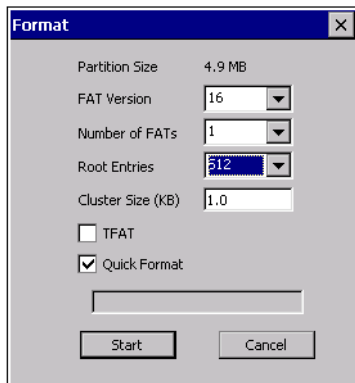

5. Choose your format options. These options include:
  - Version of filesystem (FAT-12, for devices holding up to 32 MB; FAT-16, for devices containing 16 MB to 4 GB; or FAT-32, for devices containing more than 32 MB).
  - Number of file-allocation tables.
  - Number of entries allowed in the root directory.
  - Cluster size (512 B to 64 kB).

There are also two checkboxes, which govern:

- Whether to use the transaction-safe FAT filesystem (TFAT). This filesystem keeps multiple copies of the file-allocation table, changing one while maintaining another as a backup.
- Whether to perform a quick format. Quick formatting removes all reference to data in the partition without erasing the actual partition. The partition will be treated as empty, and new data will overwrite it.

6. Press **Start**. The partition is formatted.

To mount a partition:

1. Select the desired partition.
2. Press the **Properties** button. The Partition Properties dialog appears.
3. Press the **Mount** button. The partition is mounted. The asterisk appears next to its name in the partitions list.

The Partition Properties dialog has buttons for additional functions. Partitions can be defragmented, and their file structure can be scanned.





# USING THE PC CONNECTION

# 5

5.1 Introduction . . . . .	65
5.2 Using ActiveSync. . . . .	65
5.3 Getting Help. . . . .	66
5.3.1 Where Can I Find More Help?. . . . .	66
5.3.2 Tips On Using ActiveSync Help. . . . .	66
5.4 Working With Your Files . . . . .	67
5.4.1 Looking At Files On Your NETBOOK PRO . . . . .	67
5.4.2 Copying A File Using Drag And Drop . . . . .	67
5.4.3 Copying A File Using Copy And Paste . . . . .	68
5.4.4 Opening NETBOOK PRO Files From Your PC. . . . .	69
5.5 Backing Up Your NETBOOK PRO With ActiveSync . . . . .	69
5.5.1 Performing Your First Backup. . . . .	69
5.5.2 Performing Regular Backups . . . . .	70
5.6 Synchronizing Your NETBOOK PRO . . . . .	70
5.6.1 What Is Synchronization? . . . . .	70
5.6.2 Synchronizing Your NETBOOK PRO. . . . .	70
5.6.2.1 Creating The Partnership . . . . .	70
5.6.3 Using An Existing Partnership. . . . .	73



## 5.1 Introduction

This chapter explains how to use ActiveSync to copy files between a PC and the NETBOOK PRO, and to ‘synchronize’ files between the two devices. It assumes some basic knowledge of Windows® PC operating systems.

These instructions assume that you have established a link between your PC and NETBOOK PRO. See “Setting Up ActiveSync” on page 40 for details on communication links.

- Check that a link exists between the NETBOOK PRO and the PC by looking in the PC’s System tray in the bottom right-hand corner of your desktop. There should be a green circle in the system tray if you have successfully linked, as shown.



If this circle is grey there is no connection.



- Make sure that your link cable is connected.
- On the NETBOOK PRO, check the taskbar for the blue monitor icon. If there is no icon, your unit is not connected.



## 5.2 Using ActiveSync

ActiveSync allows Windows Explorer to see files on your NETBOOK PRO, using the *Explore* icon in the ActiveSync window. You can copy your NETBOOK PRO files in most of the ways you can copy any normal PC file, including copying or moving files to your PC in order to print them. The methods outlined in this chapter are representative of ways that you might use Explorer, but are not the only possibilities.



**Note:** *You can change the look of Explorer using options in the View menu; therefore, the appearance of your own screen may vary slightly from those shown.*

## 5.3 Getting Help

### 5.3.1 Where Can I Find More Help?

ActiveSync includes comprehensive online help, which describes all of the application's features and functionality. Please consult the online help for further information or guidance on using ActiveSync.

You can display the help topics by double-clicking on the **ActiveSync** icon on the PC system tray and selecting **Help** from the menu, then **Microsoft ActiveSync Help**.



**Note:** *You can display help for a particular task or dialog by pressing the **F1** key.*

### 5.3.2 Tips On Using ActiveSync Help

From the *Help* window, you can find the information you require as follows:

#### **From the Contents tab**

you can select a topic from a structured list, e.g. how to perform a particular task, or troubleshooting information about how to solve a problem. To find the topic you want, double-click on the topic to find the general area of interest, and then choose the topic you want to display.

#### **From the Index page**

you can find the topic you want by entering any word linked to the subject, such as 'backup' to find topics containing information about how to back up your NETBOOK PRO.

#### **From the Find page**

you can search for an exact word or phrase contained within a topic, such as 'serial port' to find all the topics in the online Help containing this phrase.

## 5.4 Working With Your Files



### 5.4.1 Looking At Files On Your NETBOOK PRO

Using Windows Explorer, you can open, move, copy and delete files stored on your NETBOOK PRO from your PC.

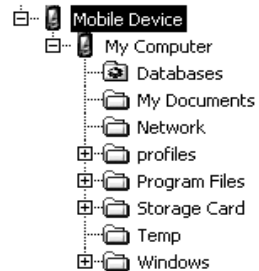
- On the PC, double-click on the **Mobile Device** icon in your PC's My Computer folder. The Mobile Device window opens, displaying icons for the files and folders in the *My Computer* folder.
- Double-click on the NETBOOK PRO's **My Computer** folder under *Mobile Device*, to display the files and folders on the drive. There will be a folder for each inserted memory card.



### 5.4.2 Copying A File Using Drag And Drop

1. Go to the folder you want to copy files from. The left-hand pane of the Explorer window shows a list of all the disk drives on your PC, along with NETBOOK PRO and network drives (if any). You can expand a branch by clicking on the  symbol next to it, or close the branch by clicking on the  symbol. The right-hand side of Explorer shows the contents of the folder selected on the left.
2. Use the scroll bar on the right of the left-hand Explorer pane until you can see the drive that contains the folder that you want to copy the file from. Left-click and hold to drag the file or folder to copy.
3. Drag the file or folder up the folder list in the left pane, until you can see the folder that you wish to copy the file into. If the folder you want to copy to is not visible because its branch has not been expanded, hover the dragged file over the folder for a second and it should expand. This step can be repeated until the folder you want is visible.
4. Drop the file onto the folder name in the left pane, or into the right pane if the folder is open, by releasing the left mouse button.

If necessary, the file is converted into the correct PC format. The file can be used in the same way as any other file on your PC.

### 5.4.3 Copying A File Using Copy And Paste

Using Windows Explorer, you can copy files between your PC and NETBOOK PRO in the same way you would copy files to a floppy disk, or another PC on a network. ActiveSync can convert files as they are copied so that you can open them on the other computer immediately.

Within Windows, clicking the right mouse button often displays a context-sensitive (pop-up) menu – a range of commands relevant to the object that you right-click on. In Explorer, you can use these menus to copy files between folders, regardless of whether they are on the PC or the NETBOOK PRO.

1. Open Windows Explorer.
2. Navigate to, and expand, the *Mobile Device* branch of the folder list. Find the folder that contains the file you wish to copy to the PC and click on it so that its contents are shown in the right-hand pane of the Explorer window.
3. Right-click on the file and select **Copy** from the pop-up menu that appears.
4. Navigate to the folder you want to copy this file to, and select it, so that its contents (if any) appear in the right-hand pane of the Explorer window. Right-click in the right-hand pane of the Explorer window, and select **Paste** from the pop-up menu.

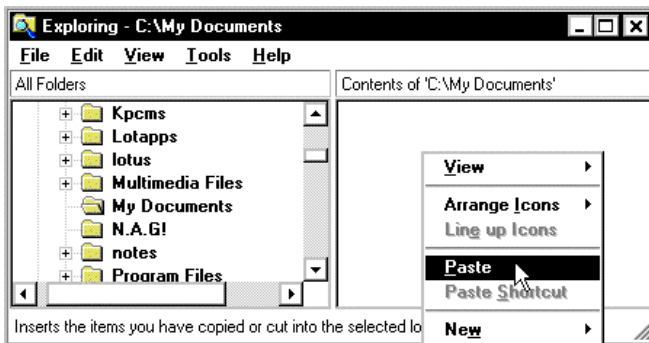

You can use Windows Explorer to manage files and folders stored on your NETBOOK PRO in the same way as you can on your PC's drives.



**Warning:** *When you delete a file on your NETBOOK PRO using your PC, it is permanently removed from the NETBOOK PRO's internal storage. The file cannot be retrieved from the PC's Windows Recycle Bin, which only stores files deleted from the PC's drives.*

## 5.4.4 Opening NETBOOK PRO Files From Your PC

You can open a file on your NETBOOK PRO using a PC application without first having to copy it to your PC drive. You can edit the file on your PC and then save it back to your NETBOOK PRO when you have finished. To open a file from Windows Explorer, navigate to the **Mobile Device** section of the file tree, locate the file, then double-click on the file icon or press **Enter**.

When you save the file from within the PC application, ActiveSync transfers the saved file back to your NETBOOK PRO.

## 5.5 Backing Up Your NETBOOK PRO With ActiveSync

### 5.5.1 Performing Your First Backup

You can use ActiveSync to back up all the files stored on your NETBOOK PRO to your PC. Keeping backups of your NETBOOK PRO files on your PC means that you have a separate copy of all your work that can be restored to your NETBOOK PRO. For example, you can restore backed up files to your NETBOOK PRO if you accidentally delete a file, wish to revert back to an older version of a file, or need to restore files if you forget to change the batteries.

To make a backup:

1. Open ActiveSync on the PC by double-clicking on the **green circle** in the taskbar.
2. Click on the **Tools** menu, then on **Backup/Restore**.
3. Click **Back Up Now** to start backing up the files on your NETBOOK PRO. ActiveSync displays a progress window showing how long the backup will take and will inform you when it has completed.

## 5.5.2 Performing Regular Backups

You can set ActiveSync to automatically backup when the device connects, so you do not need to back up your NETBOOK PRO manually.

## 5.6 Synchronizing Your NETBOOK PRO

### 5.6.1 What Is Synchronization?

You can use synchronization to manage information that you wish to keep up to date on both your PC and NETBOOK PRO. When you synchronize, ActiveSync checks the information in your PC program with the matching information on your NETBOOK PRO, and then updates the files on both your PC and NETBOOK PRO to include the new information. To synchronize, you must set up a partnership between the NETBOOK PRO and the PC.

### 5.6.2 Synchronizing Your NETBOOK PRO

This section details the set-up and day-to-day use of ActiveSync to synchronize files on the PC. The instructions assume some familiarity with the use of Windows, and that you are using ActiveSync.

Partnerships are only necessary for synchronization, not to simply copy files from the PC to the NETBOOK PRO.

#### 5.6.2.1 Creating The Partnership

1. Make sure that your NETBOOK PRO is connected to the PC via the serial cable.
2. Set the PC to listen on the port the serial cable is connected to.
3. On the NETBOOK PRO, check the *PC Connection* control panel to make sure it is set to send to the correct port.



4. On the NETBOOK PRO, click on the **Start** button, then **Programs**, then **ActiveSync**, and select **direct** from the ActiveSync menu. This will connect the NETBOOK PRO to the PC and bring up the ActiveSync dialog on the PC.

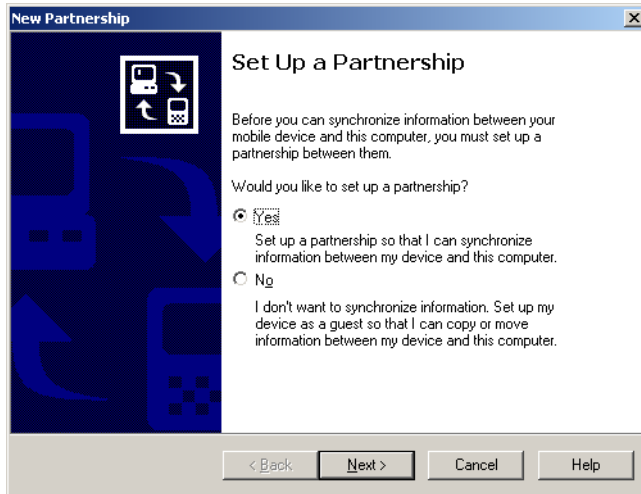

The New Partnership screen allows you to select what types of information will be synchronized.

5. Check all items to be synchronized. These can be changed after the partnership has been created.

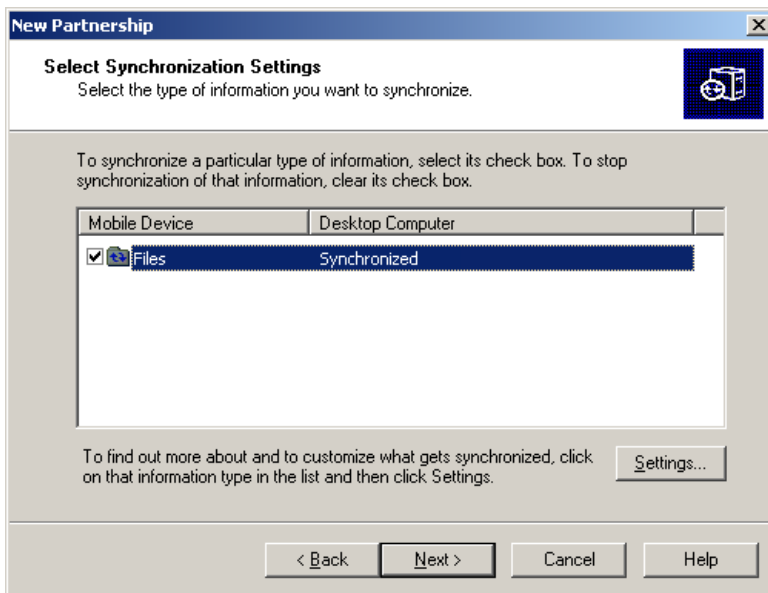

6. To customize settings for file synchronization, click on the **Settings** button. This can also be done after the partnership has been created. More information on customized settings can be found by referring to ActiveSync's online help.



**Note:** *Pocket On-Schedule, included with the NETBOOK PRO, does not use ActiveSync for its data synchronization. See "On-Schedule Outlook Sync" on page 73.*

7. Click **Next**.
8. ActiveSync will display the *Setup Complete* screen with further information on using ActiveSync. Click **Finish**.

### 5.6.3 Using An Existing Partnership

Once you have set up the partnership as above, you can use it whenever you wish. When the NETBOOK PRO and the PC are connected afterward, it will automatically use the current partnership.

To force synchronization, make sure the NETBOOK PRO and the PC are already connected. Press the **Sync** button in the PC's *ActiveSync* window. To stop synchronization, click on the **Stop** button.

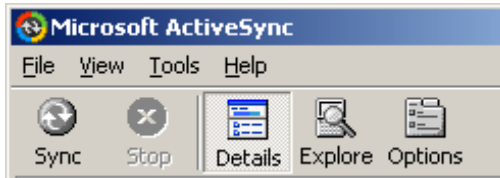

**Note:** *Hard resetting the NETBOOK PRO will delete the partnership on the NETBOOK PRO. You may delete and re-create the partnership on the PC, or create another partnership with a new name. Refer to ActiveSync's online help for more details on this operation.*

## 5.7 On-Schedule Outlook Sync

The NETBOOK PRO includes Pocket On-Schedule, a full-featured email, schedule, and contact-management program. Pocket On-Schedule comes with On-Schedule Outlook Sync, which enables it to synchronize information with Microsoft Outlook running on Windows 2000. On-Schedule Outlook Sync runs on your PC and uses the ActiveSync connection to communicate with the NETBOOK PRO.

To use On-Schedule Outlook Sync, you must be running Windows 2000 and Microsoft Outlook, and you must have already established a partnership through ActiveSync with the NETBOOK PRO.

On-Schedule Outlook Sync can be installed from the CD that accompanies the NETBOOK PRO. After installation, help for the program is available from **Start, Programs, On-Schedule, On-Schedule Outlook Sync Help**.

Help for Pocket On-Schedule itself is available on the NETBOOK PRO by selecting **Start, Programs, Pocket On-Schedule** to open the program, then selecting **File, Help Contents**. The manuals for both Pocket On-Schedule and On-Schedule Outlook Sync can also be found on the CD.



# CONFIGURING COMMUNICATIONS

# 6

6.1 Introduction . . . . .	77
6.2 802.11b Radio Configuration . . . . .	77
6.3 GSM/GPRS Radio Configuration . . . . .	80
6.4 Bluetooth Radio Configuration . . . . .	85
6.5 Internet And E-Mail Settings . . . . .	89
6.5.1 Overview . . . . .	89
6.5.1.1 Using The Internet On The NETBOOK PRO . . . . .	89
6.5.1.2 Using E-mail On The NETBOOK PRO . . . . .	89
6.5.1.3 Types Of E-mail Account . . . . .	90
6.5.1.4 If You Don't Have An Internet/E-mail Account. . . . .	90
6.5.1.5 Glossary Of Terms . . . . .	91
6.5.2 Setting Up Your NETBOOK PRO . . . . .	92
6.5.2.1 How To Use Internet Explorer/Inbox . . . . .	92
6.5.2.2 Getting Help . . . . .	92
6.5.2.3 What Information Do I Need? . . . . .	93
6.5.3 Setting Up E-mail On NETBOOK PRO . . . . .	94
6.5.3.1 Connecting The Modem . . . . .	94
6.5.3.2 Setting Up Dialing . . . . .	95
6.5.3.3 Setting Up The Internet Service . . . . .	96
6.5.3.4 Setting Up The Modem . . . . .	96
6.5.3.5 Setting Up The E-mail Program . . . . .	97



## 6.1 Introduction

Before you can use Internet Explorer (the Internet browser) and Inbox (the e-mail application), some basic configuration is necessary for the specific type of radio card that you've inserted in your NETBOOK PRO.

## 6.2 802.11b Radio Configuration

The following are the basic settings necessary to be able to run the NETBOOK PRO on an 802.11b radio network.

1. When the NETBOOK PRO is turned on, the radio configuration icon should be in the system tray. It may take a few minutes to appear. The configuration dialog is also displayed.

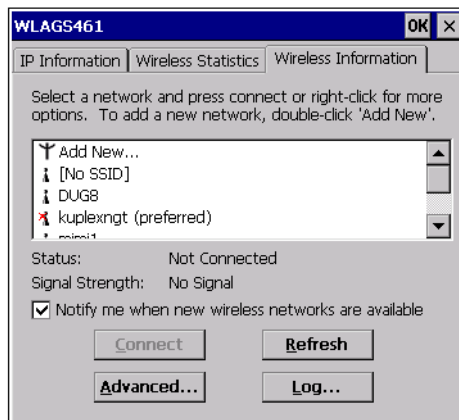

2. By clicking on **Advanced** in the *Wireless Information* tab, you can access the settings screen to adjust priority of network connections.



3. Select the **Use Windows to configure my wireless settings** checkbox.
4. You can add a network, configure WEP for security, and enable IEEE 802.1X authentication by double-clicking on the **Add New** selection in the *Wireless Information* tab

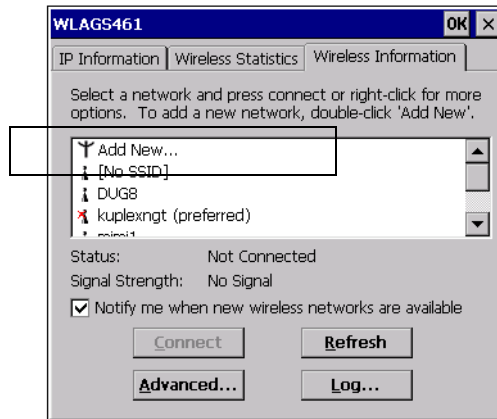

5. The *Wireless Network Properties* dialog opens for a new network.



**Note:** Double-click on an existing network in the list to open the *Wireless Network Properties dialog* and display the parameters of the existing network.



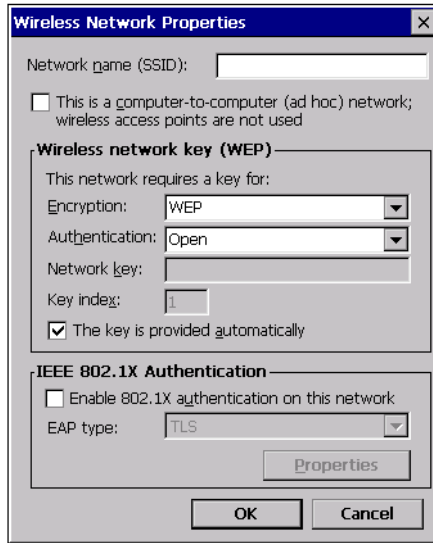

6. IEEE 802.1X is an authentication protocol that can be used with IEEE 802.11b networks (see menu screen on next page). Currently, **MD5 Challenge** and **TLS** are the EAP (Extensible Authentication Protocol) types supported by the NETBOOK PRO. The *EAP type* setting must match the configuration of the RADIUS Server on the wired network. In addition to this, the access point must support IEEE 802.1X and must be configured appropriately.
7. Selecting **Advanced** in the *Wireless Information* tab will allow you to configure the types of networks to connect to.

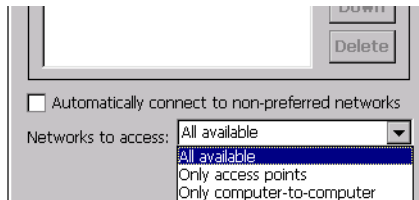

## GSM/GPRS Radio Configuration

- Click on **OK** to save your settings. These settings can also be changed by entering the *Control Panel* and clicking on **Network and Dial-Up Connections**, then on the adaptor name.



## 6.3 GSM/GPRS Radio Configuration

The following menus provide the configuration settings for the GSM/GPRS Globe-trotter Option radio card. For details on setting up a modem through the serial port, please refer to “Connecting The Modem” on page 94.

The following information is required from the GSM/GPRS network operator:

- Access Point Name (APN).
- Username and Password (if applicable).
- Some network operators also specify the IP address and NDS settings to be used. Please consult the network operator for specific configuration parameters.

You will also need a SIM for a GSM account that has GPRS enabled. To set up the GSM/GPRS connection:

1. Insert the GSM/GPRS radio card, with SIM, in the NETBOOK PRO.
2. Open the *Control Panel*.
3. Double-click on the **Networks and Dial-Up Connections** icon. The following selections will appear.



4. Double-click on the **Make New Connection** wizard to access the following menu. Type the connection name “GPRS” into the text box, and verify that the **Dial-Up Connection** radio button is selected. Click on the **Next** button.

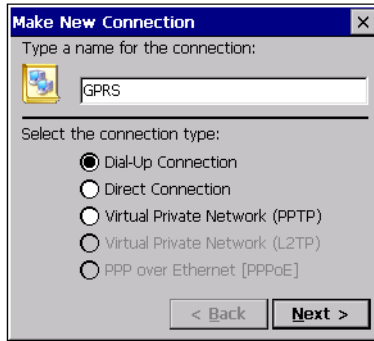

5. Select the GSM/GPRS card from the dropdown list in the *Modem* dialog.



6. Click on the **Configure** button next to the dropdown list, and the following menu appears. From the *Baud Rate* dropdown list, select **115200**.

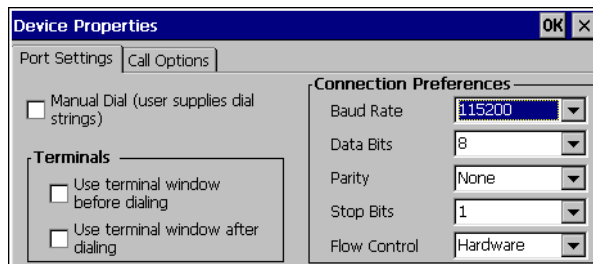

7. Then click on the *Call Options* tab to access the following menu.

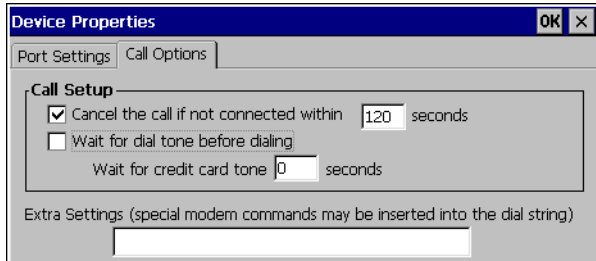

8. Uncheck the **Wait for dialtone before dialing** box and click **OK**. The *Modem* selection screen will return. Click on the **Next** button.
9. The following menu appears. Enter the phone number. Most providers use **\*99#** as the GSM/GPRS phone number.



10. Click on the **Finish** button. The *Network and Dial-Up Connections* screen reappears. You should now see a connection called "GPRS".
11. Open the *Control Panel*.
12. Double-click on the **APN Manager** icon. The *APN Manager* dialog appears:

13. In the APN Manager, click on the **Add** button.

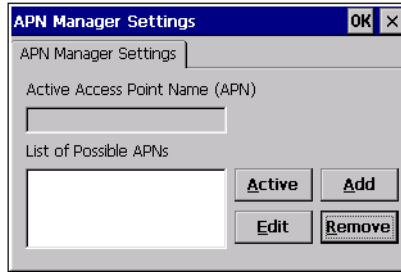

14. Enter the name of the APN, as supplied by the GSM/GPRS service provider, in the box.
15. Click on the **OK** button. The *APN Manager* dialog disappears, and the *Network Connections* screen reappears.
16. Double-click on the new **GPRS** connection. This will bring up the *Dial-Up Connection* dialog. Click on the **Dial Properties...** button.

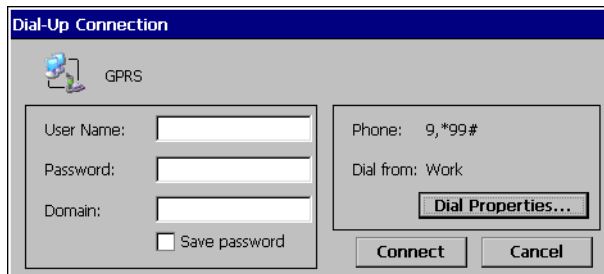

17. This will bring up the *Dialing Properties* dialog box.

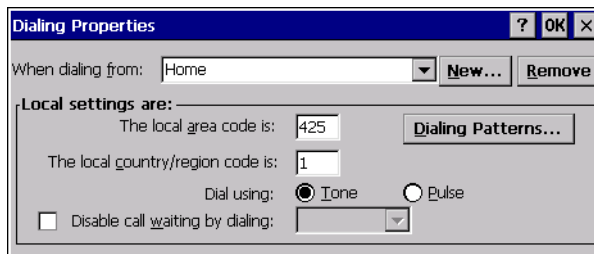

18. Click the **New** button. The *Create New Location* dialog appears.

19. Enter the name GSM-GPRS for the new dial location.
20. Press **OK**. The *New Dial Location* dialog reappears.
21. Press the **Dialing Patterns** button. The *Dialing Patterns* dialog appears.

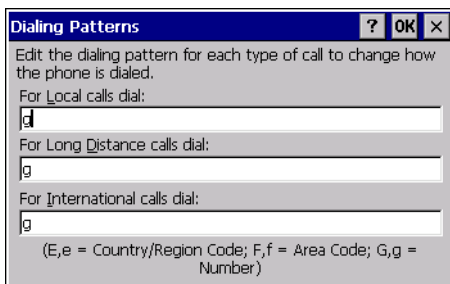

22. Enter 'g' for the dial strings. This instructs the connection to dial the phone number with no additional characters.
23. Press the **OK** button. The *Dialing Properties* dialog reappears.
24. Press the **OK** button. The new dial location is saved.
25. From the *When dialing from:* dropdown list, select **GSM-GPRS**. Click **OK**.

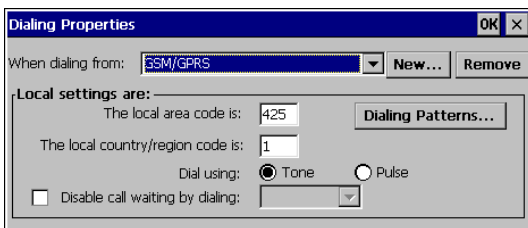

26. The *Dial-Up Connection* screen reappears.



The new GSM/GPRS dial-up connection is now configured.

You may need a username and password to use the connection. These are provided by your service provider.



**Note:** *Not all providers require a user name or password.*

To use the GSM/GPRS connection:

1. Double-click on the connection icon. The *Dial-Up Connection* dialog appears.
1. Enter your *User Name* and *Password*, if your provider has given you one.
2. Click on the **Connect** button.



**Important:** *While GSM/GPRS is active, ActiveSync will not be available.*

## 6.4 Bluetooth Radio Configuration

Bluetooth is a global standard for wireless connectivity for digital devices. The technology is based on a short-range radio link that operates in the ISM band at 2.4 GHz. When two Bluetooth-equipped devices come within 10 meters' range of each other, they can establish a connection. Because Bluetooth uses a radio-based link, it doesn't require a line-of-sight connection in order to communicate.



**Note:** *The Bluetooth radio card uses an internal antenna.*

The following menus provide the configuration settings for the Bluetooth radio card. For details on setting up a modem through the serial port, please refer to “Connecting The Modem” on page 94.



**Important:** *Other Bluetooth devices that connect with the NETBOOK PRO may use different terminology for some features (i.e. Authentication, Pairing, Bonding, etc.). Verify that the features being configured are the same on each device.*

## 6.4.1 NETBOOK PRO Bluetooth Settings

1. Open the Control Panel and double-click on the **Bluetooth Device Properties** icon.

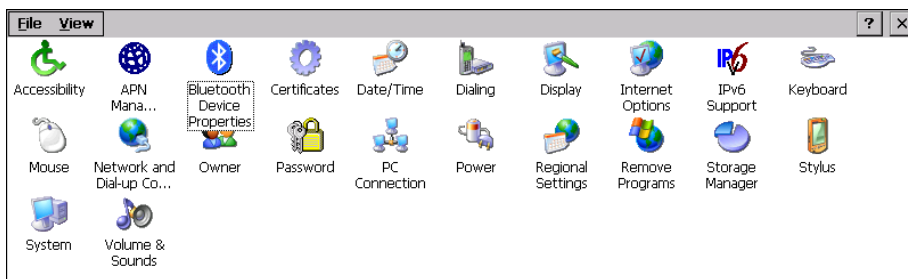

The *Bluetooth Manager* dialog opens.

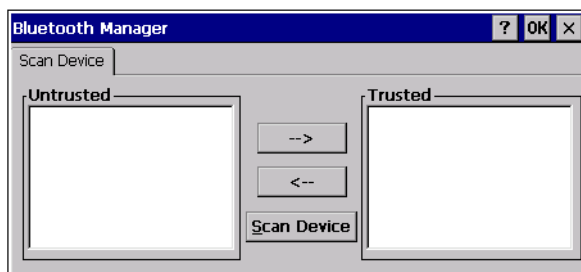

2. Ensure that the intended device (another NETBOOK PRO, a Zebra<sup>®</sup> printer, etc.) is powered on and that its Bluetooth radio is enabled (this is automatic for Zebra printers and the NETBOOK PRO).
3. Click on the **Scan Device** button and wait for the NETBOOK PRO to complete its scan (approximately 20 seconds). Services offered by discovered devices will be displayed on the left side in the *Untrusted*



list box. Each service of a device receives a separate entry:

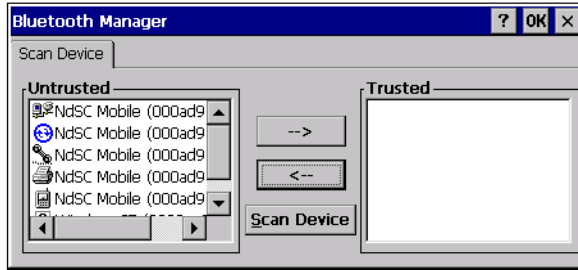

If the discovered device has been given a unique name by its owner, that name is used to identify it.



**Note:** You can change the device-name and description of your radio by clicking on the **System** icon in Control Panel, which will open the System Properties page. Click on the Device Name tab to access the menu and change your settings. Then click on **OK**.

Although the name will have changed in the Property screen, the radio only reads it on boot-up. Therefore, for the changes to take effect, you must reset the NETBOOK PRO (see “Resetting The NETBOOK PRO” on page 30).



4. A discovered device may display several service profiles that it can use to communicate. Supported services that can be activated include: dial-up networking service, serial connections for printing, and LAN access using PPP.

5. Highlight the desired service profile in the *Untrusted* list, then click on the **right arrow** (->) button to transfer it to the *Trusted* list. A dialog appears asking whether authentication is needed:

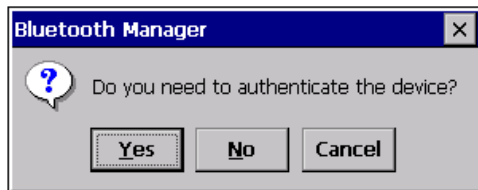

If authentication is needed for the service, click **Yes**, then enter the PIN:

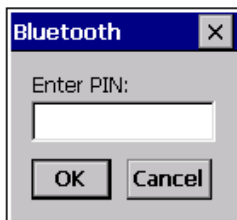

6. When the device's service profiles are displayed in the *Trusted* list box, double-click the desired service to display its popup menu, then select **Activate** or **Deactivate**, which will make the required service "active" or "inactive".
7. When the NETBOOK PRO tries to connect with a remote device that has Authentication enabled, you will be prompted to verify the PIN. The *Authentication Request* dialog will appear. Enter the **PIN**, press **OK**, and the devices will be connected.

The NETBOOK PRO is now ready to run application software to communicate with the required device.

## 6.5 Internet And E-Mail Settings

### 6.5.1 Overview

Before you can use Internet Explorer (the Internet browser) and Inbox (the e-mail application) on your NETBOOK PRO, you need to set up certain details. This section covers some general questions that people ask about using e-mail and the Internet, and provides a glossary of terms. The later sections list the information you will need to know before you start setting up the NETBOOK PRO, and then provide step-by-step instructions.

#### 6.5.1.1 Using The Internet On The NETBOOK PRO

You can use your NETBOOK PRO to:

- Access the Internet and view web pages using the Internet Explorer program.
- View locally stored web pages and graphics files.
- Download files, e.g. additional programs for your NETBOOK PRO.

#### 6.5.1.2 Using E-mail On The NETBOOK PRO

You can use your NETBOOK PRO to send and receive e-mail messages by connecting to a remote mailbox:

##### Connecting By Telephone Line To A Remote Mailbox

This is for making a ‘live’ connection to your e-mail mailbox via a telephone line (without needing a PC). For example, you could access your personal mailbox by dialing your Internet Service Provider (ISP), or access your work mailbox by dialing your company's service provider or office mailbox.

##### ***What to do next...***

If you want to access your work mailbox, you will first need to contact your network administrator to find out whether you can make a ‘remote’ (dial-up) connection to your mailbox. See “Types Of E-mail Account” on page 90 to continue.

### 6.5.1.3 Types Of E-mail Account

There are a number of different types of e-mail account. See the list below to find out which types of account you can connect to using the e-mail program on your NETBOOK PRO.

#### Personal Dial-up Account

This is most likely a dial-up e-mail account which you've signed-up for with an Internet Service Provider (ISP).

##### *Which ISPs can I use?*

You can use most ISPs which use 'Internet standard' methods for connecting to your e-mail account. However, some ISPs (such as America Online) use proprietary methods for connecting, and cannot be accessed by your NETBOOK PRO (i.e. you must use a PC). Move on to '*Setting up your NETBOOK PRO*' to continue.

#### Remote (e.g. Office) E-mail Account

This is most likely an e-mail account at your workplace, e.g. using Microsoft Exchange or Lotus Notes.

##### *How do I find out if I can use my account?*

You will need to find out from your network administrator whether you can access your e-mail mailbox using this type of account. If you can, move on to "Setting Up Your NETBOOK PRO" on page 92 to continue.

#### Web-based E-mail Account

This is an e-mail account that you must connect to using a web browser, such as HotMail or Yahoo! Mail.



**Note:** *You can't connect to this type of account using the e-mail program.*

*To use web-based e-mail, you must first set up your NETBOOK PRO for Internet access. You will need to use the Internet Explorer program to access your e-mail provider's web site.*

### 6.5.1.4 If You Don't Have An Internet/E-mail Account

You will require an e-mail account before you can access the Internet, and send and receive e-mail messages on your NETBOOK PRO.

- To get a personal e-mail account, you must ‘sign-up’ with an Internet Service Provider (ISP). ISPs usually provide an e-mail account as part of an Internet access package.
- Most ISPs will provide software (e.g. a CD-ROM) which will help you set up Internet access and the e-mail account on a PC.



**Important:** *Some ISPs require that you connect to them using a PC in order to sign-up. If you can't do this, contact the ISP to find out if you can sign-up without using a PC. If you have Internet access, see [www.pSION.com/mobile](http://www.pSION.com/mobile) for more details.*

### 6.5.1.5 Glossary Of Terms

#### DNS

The Domain Name System (DNS) is an Internet service that translates domain (or ‘host’) names into IP addresses. Domain names are alphabetic but the Internet is based on numeric IP addresses. Therefore when a domain name is used, a DNS service must translate the name into the corresponding IP address. For example, the domain name *www.pSIONteklogix.com* might translate into the IP address *194.129.243.153*.

#### Hostname (or Domain Name)

A unique identifier in alphabetic characters for a network device.

The hostname corresponds to the device’s numeric IP address. For example, *www.pSIONteklogix.com* could be the same as the IP address *194.129.243.153*.

#### IP address

A computer’s unique Internet address, e.g. *194.129.243.153*, used by computers to communicate with each other.

#### ISP

Internet Service Providers are companies that provide you with access to the Internet. An ISP ‘account’ normally includes the facility to send and receive e-mail using a personal e-mail address.

#### POP3/IMAP4

Internet ‘protocols’ (standards) for receiving e-mail.

#### SMTP

An Internet protocol used for sending e-mail.

#### TCP/IP

An Internet protocol used by computers to communicate with each other.

## 6.5.2 Setting Up Your **NETBOOK PRO**

### 6.5.2.1 How To Use Internet Explorer/Inbox

To access the Internet, and send and receive e-mail on your **NETBOOK PRO** you must have the following:

1. An appropriate **e-mail account**.  
To access the Internet and use e-mail, you will need a standard e-mail account.
2. A **modem**.  
You will need a modem to connect your **NETBOOK PRO** to the telephone network. You can use the following types of modem with your **NETBOOK PRO**:
  - Standard external PC modems.
  - PCMCIA- and CF-card modems.
  - GSM radio modem, see “GSM/GPRS Radio Configuration” on page 80 for details. These are available as PCMCIA and CF cards.
  - Infrared-enabled or Bluetooth-enabled mobile phones with built-in modems.
3. A **telephone connection**.  
If you are using a standard external modem, you will need to connect your modem to a telephone socket. If you are using a mobile phone, your network operator will need to enable your account so that you can make fax and data calls on your phone. If your phone has been enabled for fax and data calls, you should have two extra phone numbers. Contact your network operator if you are unsure whether your account is ‘data-enabled’.

### 6.5.2.2 Getting Help

If you are having connection problems, you can find information about connecting using specific service providers, modems or mobile phones on our web site at [www.pSION.com/mobile/](http://www.pSION.com/mobile/).

### 6.5.2.3 What Information Do I Need?

Before you can set up your NETBOOK PRO, you will need to find out some information about your modem and your Internet e-mail account by:

- Checking any documentation your ISP supplied about your Internet account, or contacting your network administrator at work.
- Checking your ISP's web site for technical support.
- Contacting your ISP by e-mail or phone for technical support.
- Checking the Psion Teklogix web site at [www.pSION.com/mobile](http://www.pSION.com/mobile) for details of worldwide ISPs.

#### Information Checklist

The checklist in Table 6.1 shows what information you will need to set up your NETBOOK PRO. Only your ISP or your network administrator can supply all the information required about your Internet e-mail account.

Information You Need	Where To Find It	Write It Here
<b>Speed</b> at which you should use your modem (called the baud rate or bit rate).	Your modem's documentation.	
<b>Phone Number</b> you need to dial to connect to your ISP (often called a Point of Presence or POP).	From your ISP/administrator.	
<b>User name</b> for your Internet account.	From your ISP/administrator, e.g. "jrook" or "nd44".	
<b>Password</b> for your Internet account.	From your ISP/administrator, or you may have chosen this yourself.	
<b>POP3</b> or <b>IMAP4</b> server address (for incoming messages).	From your ISP/administrator e.g. "pop3.myisp.com".	

Table 6.1 Information Checklist

<b>SMTP</b> server address (for outgoing messages).	From your ISP/administrator e.g. "smtp.myisp.com".	
<b>E-mail Address</b> (your personal address).	From your ISP/administrator e.g. "myname@myisp.coml".	

**Table 6.1 Information Checklist**

Some service providers require additional information to 'log on' to their server. You may need the following information when using some service providers.

<b>Optional Information</b>	<b>Where To Find It</b>	<b>Write It Here</b>
<b>IP Address</b> (if your ISP's server doesn't provide one automatically).	From your ISP/administrator e.g. "194.129.243.153".	
<b>DNS Addresses</b> (primary and secondary DNS addresses if your ISP's server doesn't provide them automatically).	From your ISP/administrator e.g. "123.255.78.90" and "123.255.78.92".	
<b>Mailbox Login</b> (if different from your Internet account user name).	From your ISP/administrator.	
<b>Mailbox Password</b> (if different from your Internet account password).	From your ISP/administrator, or you may have chosen this yourself.	

**Table 6.2 ISP Additional Information**

## 6.5.3 Setting Up E-mail On NETBOOK PRO

If you have collected all the information in the checklist, you are now ready to set up your NETBOOK PRO to connect to your ISP.

### 6.5.3.1 Connecting The Modem

1. Connect your NETBOOK PRO to the modem using the NETBOOK PRO's serial cable.



*What Do I Need To Do This?*

To connect your NETBOOK PRO serial cable to your modem you may require a Psion Teklogix modem cable adaptor. You can **only** use a Psion Teklogix adaptor, which can be obtained from your local distributor.

2. Connect your modem to the telephone socket and switch on the modem.

### 6.5.3.2 Setting Up Dialing

When you connect to the Internet, your NETBOOK PRO will need to dial your service provider's telephone. You can set up different dialing 'locations' so that your NETBOOK PRO knows how to dial the number correctly, e.g. if you're dialing from the 'office' location, you might need to add a '9' before the number you want to dial.

To set a dialing location:

1. Open the Control Panel by left-clicking the **Start Menu** command icon on the far right-hand side of the display, or by clicking on **Start** in the taskbar, then **Settings**, and then **Control Panel**.
2. Open the **Dialing** icon  to display the *Dialing Properties* menu.

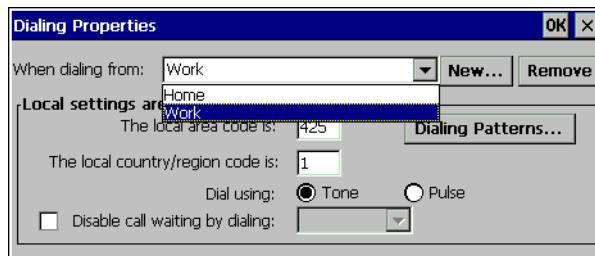

3. The NETBOOK PRO comes with two default locations, Home and Work. Adjust these to suit your needs by selecting the location in the dropdown box and editing the associated information. For more control over dialing patterns, push the **Dialing Patterns...** button.

If you don't want to use any of these pre-defined locations, you can add a new location. It will appear selected in the drop-down list, ready to edit.

4. Click on **New** and enter the name of the new location.
5. The dropdown will display the new location. Edit as described above.
6. Click on **OK** when you have finished setting up your dialing location.

### 6.5.3.3 Setting Up The Internet Service

To set up a new dial-up connection:

1. Open the Control Panel.
2. Open the *Networks and Dial Up Connection* icon.
3. Double-click on the **Make New Connection** icon.  Make New Connection
4. Enter the name for the dial-up connection, usually the name of the ISP. Select the **Dial-Up Connection** radio button. Click **Next**.

### 6.5.3.4 Setting Up The Modem

After you have named your connection, you will set and configure your mode.

5. From the dropdown menu, select the correct modem.
6. Click on **Configure** to open the modem properties. The default settings for the modem should only be changed if the modem manufacturer's instructions indicate such.
7. After selecting and configuring a modem, click **Next** to continue to the *Phone Number* screen. Set the phone number. Click **Finish**.

8. The *Dial-Up Networking* screen should show your new connection with the dial-up icon.

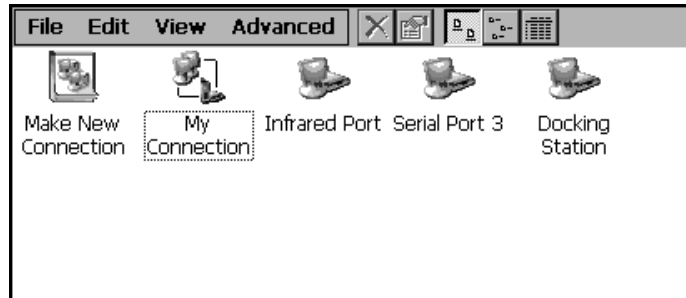

9. To connect, double-click on the connection. You must enter your user name and password.

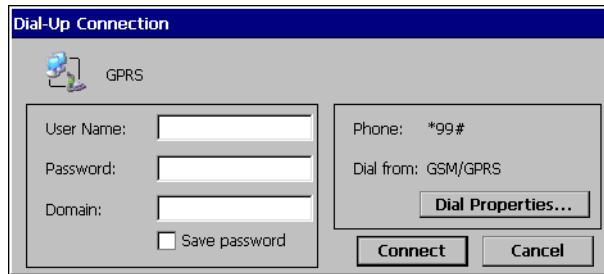

10. When you have finished entering the settings, click on **Connect** to dial the modem and make the connection.

### 6.5.3.5 Setting Up The E-mail Program

Once you have set up your Internet service, you can set up your e-mail account in the email, contacts, and scheduling program, Pocket On-Schedule.

To create a new email account:

1. On the NETBOOK PRO, click on the **Start** button, then **Programs**, then **Pocket On-Schedule**.
2. Select **Options** from the *View* menu. The *Options* dialog appears.

## Setting Up E-mail On NETBOOK PRO

3. Select **Email** from the options tree at the left. General email options appear.
4. Expand the **Email** part of the tree. Select **Account**. Options for the email account appear.
5. In the *Email Account Management* tab:
  - Click **Add**. The *Account Name* screen appears.
  - Enter a name. Press the **Next** button.
  - Enter your email address. Press the **Next** button.
  - Select the type of email server, and enter the addresses for its inbound and outbound servers. Press the **Next** button.
  - Enter your username and password.
  - After configuring the email account and clicking **Finish**, you should see your account listed on the *Account Management* dialog. Click **OK**.



**Note:** *In the Account Management dialog, you can select the account, then press the Properties button, to review and change the account's settings.*

*Additional options for configuring On-Schedule are available from the other parts of the Options dialog.*

# TROUBLESHOOTING AND TIPS

# 7

7.1	General Tips . . . . .	101
7.1.1	Times Aren't Correct In The Time Program . . . . .	101
7.1.2	If You Forget Your Password . . . . .	101
7.1.3	The NETBOOK PRO Doesn't Turn On/Off . . . . .	101
7.1.4	Resetting The NETBOOK PRO . . . . .	102
7.1.5	Battery Life Of The NETBOOK PRO . . . . .	102
7.1.5.1	Charging Times . . . . .	103
7.2	ActiveSync Connection Problems Using Windows® 95/98/NT 4.0 . . . . .	103
7.2.1	Tips When Installing ActiveSync . . . . .	103
7.2.2	Basic Troubleshooting For Your NETBOOK PRO . . . . .	104
7.2.3	Basic Troubleshooting For Your PC . . . . .	104
7.2.4	Device Conflicts . . . . .	106
7.2.5	Fax/Modem On COM 1/2/3/4. . . . .	108
7.2.6	Temp Folder. . . . .	109
7.3	Troubleshooting ActiveSync Synchronization Problems . . . . .	111
7.3.1	Basic Troubleshooting For Synchronization Problems . . . . .	111
7.3.2	Other Things To Try . . . . .	112



## 7.1 General Tips

You should read this chapter if you have any questions or experience problems using your NETBOOK PRO.

### 7.1.1 Times Aren't Correct In The Time Program

This is likely to be because of “daylight saving” or “summer time” settings (where clocks are put forward for the summer months).

The dates that clocks are set to change vary from country to country, and sometimes even within a country; some countries do not use summer times at all. Therefore, the NETBOOK PRO clock will not change automatically on the date that the clocks change. You will need to make sure that each zone is set to use its “summer time” setting when the clocks change in those countries.

### 7.1.2 If You Forget Your Password

If you forget the power-on password, you will not be able to use the NETBOOK PRO unless you reload the operating system. To do this:

1. Press a thin object such as an unfolded paper clip onto the reset switch. The NETBOOK PRO turns off.
2. Press and hold the **Ctrl**, **D**, and **On** keys simultaneously. The NETBOOK PRO's boot loader appears.
3. Press the **!** (exclamation mark) key. The NETBOOK PRO reloads its operating system and displays the *Desktop*.



**Warning:** *All installed programs and files in internal storage, except for those in the Flash folder, will be lost and cannot be retrieved. Registry entries will also be deleted.*

### 7.1.3 The NETBOOK PRO Doesn't Turn On/Off

If the NETBOOK PRO doesn't seem to turn on:

## Resetting The NETBOOK PRO

- Recharge the main battery. If you continue to use the NETBOOK PRO when the main battery is low, it will eventually not have enough power and the NETBOOK PRO will switch off. You will not be able to switch it on again until you reconnect the AC power to recharge the battery, or replace the main battery with a charged one.

If the NETBOOK PRO doesn't seem to turn off:

- Check the automatic switch off time using the **Power** icon from the Control Panel. See “Power Management” on page 14.

### 7.1.4 Resetting The NETBOOK PRO

If you find that you cannot exit a program normally, right-click or alt-tap on the taskbar and select **Task Manager** from the context menu. Select the task that appears to be unresponsive and click on the **End Task** button.

Press **Alt Tab** or **Ctrl Alt Delete** briefly to bring up the task manager. This is useful when a misbehaving program is monopolizing system resources and slowing the system.



**Note:** *If you hold **Ctrl Alt Delete** for more than 3 seconds, the NETBOOK PRO will soft reset.*

If this does not work, or if your NETBOOK PRO appears to have “locked up”, you can always perform a “reset”. For instructions, please see “Performing A Soft Reset” on page 31. This should restart your NETBOOK PRO while preserving most of your information.

It is worth trying a reset if the keys on the NETBOOK PRO do not appear to respond, or if the NETBOOK PRO appears to switch on and you are sure that the batteries are good, but the screen is otherwise blank.

### 7.1.5 Battery Life Of The NETBOOK PRO

Many variables affect NETBOOK PRO power consumption and battery life. Unlike batteries using other chemistries, Lithium Ion batteries do not suddenly fail unless they have been abused in some way. The battery capacity gradually reduces over the lifetime of the battery. Typically, the capacity of a NETBOOK PRO battery pack will decline by approximately 15-20% of initial capacity over 400 charge/discharge cycles. The battery capacity also declines slowly with aging, i.e. in storage.



Conventionally, the NETBOOK PRO battery pack is considered to have reached 'end-of-life' when its capacity has declined to 50% of the pack's initial capacity. Therefore, a NETBOOK PRO battery pack will typically reach its 'end of life' after approximately 1000 charging/discharge cycles (although the battery will still work for some time after this point).

### 7.1.5.1 Charging Times

The standard NETBOOK PRO battery charging solution does not use trickle charging or fast charging. The NETBOOK PRO battery pack is charged at a constant rate. The actual charge time experienced is dependant on capacity of the battery pack and the ambient temperature. The approximate charging time is 3 to 4 hours.

## 7.2 ActiveSync Connection Problems Using Windows® 95/98/NT 4.0

This section is a guide to troubleshooting connection problems between a NETBOOK PRO and a PC running Windows® 95/98/NT 4.0 and ActiveSync. It also presumes you have already gone through the online help documents that come with ActiveSync, and still have no success in linking. A basic knowledge of using the NETBOOK PRO and Windows 95/98/NT 4.0 is necessary. For information about using Windows 95/98/NT 4.0, check your Windows manual or contact the Windows helpline.

### 7.2.1 Tips When Installing ActiveSync

Close any other programs that are running. This includes virus checkers, uninstallers, floating toolbars etc. If you need to re-install ActiveSync, make sure you uninstall the previous version first.

1. Click on the **Start** button and select **Settings**, then **Control Panel**.
2. Double click the **Add/Remove Programs** icon. Select **ActiveSync** in the list and then click the **Add/Remove** button.



**Important:** *You must re-start your PC before re-installing ActiveSync or you will experience problems.*

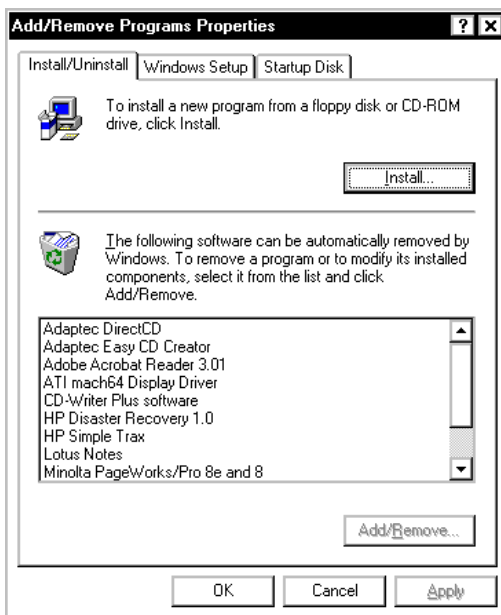

## 7.2.2 Basic Troubleshooting For Your NETBOOK PRO

1. Close down all applications. To see all active programs, look on the taskbar. Each program running will have a button. The programs can be activated then closed normally, or if necessary, you can right-click on the program's taskbar button and choose **Close** from the context menu.
2. Check that the **PC Connection** setting in the Control Panel is enabled and set to the correct serial port. Note that a partnership must already exist for the Infrared port to use ActiveSync correctly.
3. Perform a soft reset on the NETBOOK PRO.

## 7.2.3 Basic Troubleshooting For Your PC

1. Close down any other open applications in Windows.
2. If you have a laptop:
  - Make sure you have no PC Cards (PCMCIA cards) plugged in.

- Most laptops have power-saving features that disable the COM ports. Turn these power saving options **OFF**.
  - If your PC has an Infrared port, make sure it is **disabled** and your serial/COM ports are **enabled**. Psion Teklogix can support you with any of these issues. Check the laptop's manual or contact the manufacturers support department to get these issues rectified.
3. The ActiveSync Connection server icon is in the bottom right-hand corner of your PC Screen. When you are not connected, it is a grey circle. When you have made a successful connection, it becomes a green circle.

- Right-click the **ActiveSync** icon and choose **Connection Settings** from the context menu.
- Make sure that the correct connection type is checked.

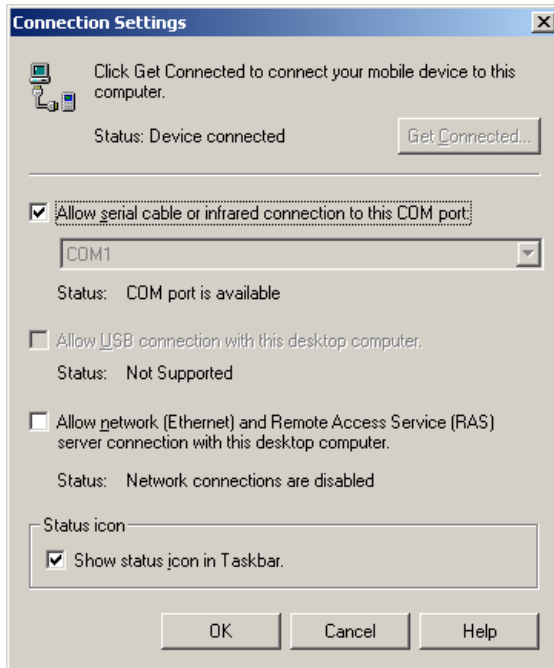
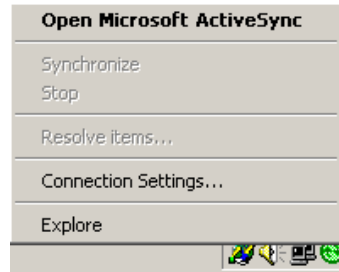

## Device Conflicts

- It is possible for ActiveSync to conflict with a modem or mouse. Symptoms are the mouse pointer intermittently locking up or software that uses the modem intermittently freezing. Check your PC's device manager for conflicts.
4. If you are using Windows NT 4.0, check that you have at least Service Pack 3 installed. If necessary, install it or contact your Systems Administrator.

### 7.2.4 Device Conflicts

To check for device conflicts:

1. Click on the **Start** button, select **Settings** and then **Control Panel**.
2. Double-click on the **System** icon.
3. On the *Device manager* page of the System properties dialog, check for icons marked with a  symbol.



**Note:** *This symbol means that the marked device is conflicting with another device. If a modem or COM port is conflicting, this could be a cause of ActiveSync not connecting. Contact the person or organization that supports your PC to resolve the conflict.*

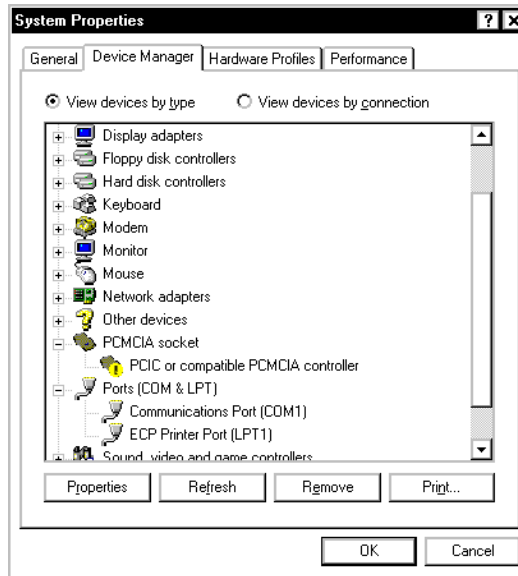

4. There is no Device Manager in Windows NT 4.0. The closest is a list of IRQs, I/O ports and DMA channels. These are accessed by the **Start** button, selecting **Programs**, then **Administrative Tools (Common)**, then **Windows NT Diagnostics**. Select the **Resources** page in the *Windows NT Diagnostics* dialog box. If you do not have this option or you are in any doubt about it, you should contact your Systems Administrator.

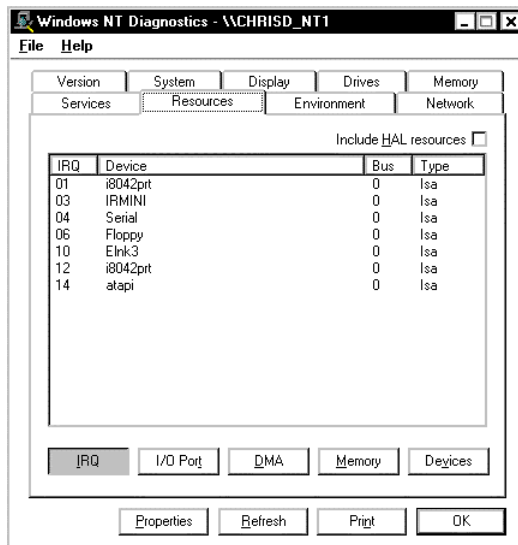

## 7.2.5 Fax/Modem On COM 1/2/3/4

If you have a Fax/Modem using COM Port 3 or 4, and ActiveSync on COM 1 or 2 (or vice versa), you may have trouble when trying to connect with the NETBOOK PRO.

Because of the way a PC handles COM ports, COM1 and COM3 are 'linked', as are COM2 and COM4. Specifically, they share the same Interrupt Request (IRQ).

In practice, this means that if you have a modem on COM3, it may conflict with the NETBOOK PRO on COM1 (and the same applies for COM4 and COM2). The solution is to try using ActiveSync on a different port or to assign a different IRQ.

You can check the COM port properties by following the steps above to get to the *Device Manager* page and double-clicking on the COM port.

Again, if you are in any doubt about whether you are able to do this safely, you should contact the person or organization that supports your PC.

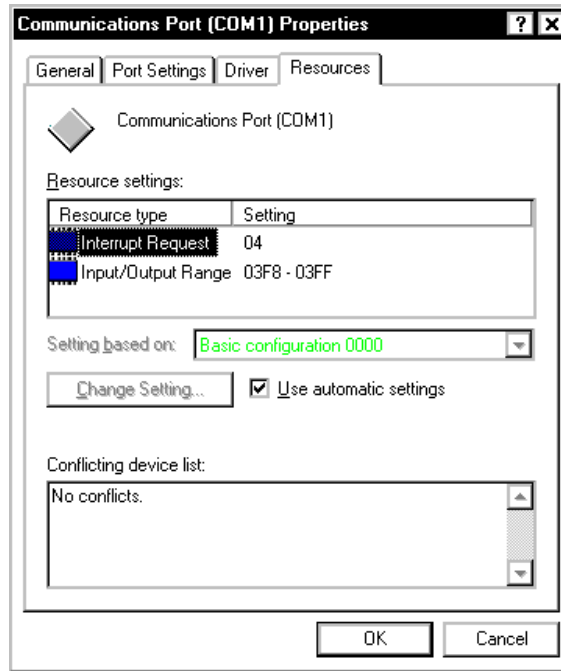

If you have an external modem and have unplugged it to use the Psion Teklogix serial cable on the same port, you will not get a connection. Windows 95/98/NT 4.0 reserves this port for use with the modem and so you will have to use another port.

## 7.2.6 Temp Folder

The ActiveSync connection can be affected if you have not specified, or have incorrectly specified, your Temp folder. To specify this:

1. Click **Start** and select **Run**. Type **sysedit** in the dialog and click **OK**.

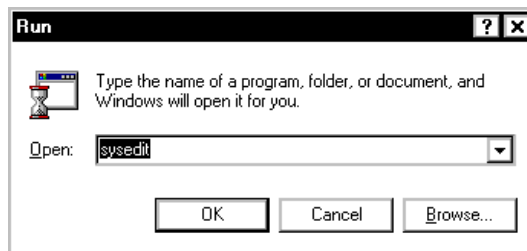

A screen with multiple windows is displayed.

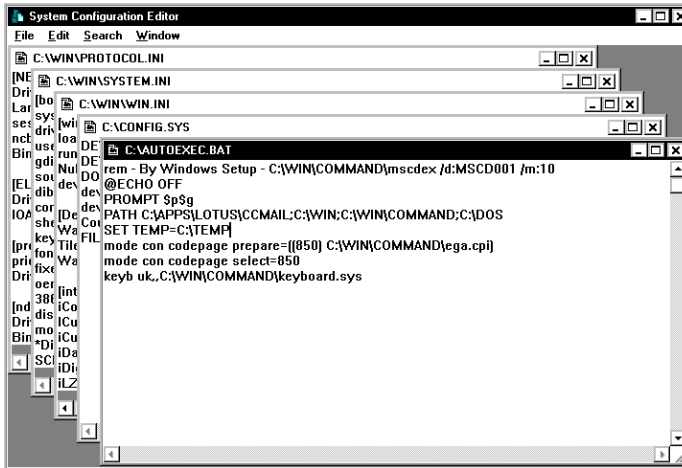

2. Click on the **AUTOEXEC.BAT** title bar.
3. Look in this window to see if it has a line that starts **SET TEMP=**. If this line exists, check that the folder that it points to exists, and create the folder if not.

If this line doesn't exist, place the cursor on a new line and type **SET TEMP=C:\TEMP**.

Close the window. Select **Yes** when asked if you want to save the changes.

4. Create a folder on the root of your C drive and call it **Temp**.

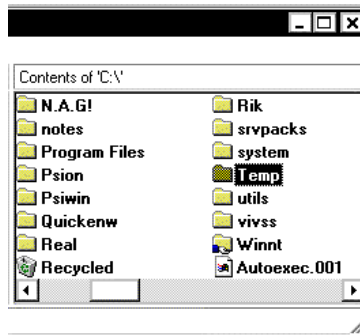

5. Finally, restart your PC.



## 7.3 Troubleshooting ActiveSync Synchronization Problems

This section discusses various problems that may be encountered when synchronizing using a partnership.

Some familiarity with these applications, Windows 95/98/NT 4.0, and your NETBOOK PRO is assumed. You will also need a full installation of your PC PIM.



**Note:** *This section should be used in conjunction with the manual to setting up a synchronization for each application.*

The majority of synchronization problems are caused by setting up a synchronization incorrectly. Please make sure you have read the appropriate sections in Chapter 5: “Using The PC Connection” first. These explain the correct way to set up a synchronization.

### 7.3.1 Basic Troubleshooting For Synchronization Problems

Some common causes of synchronization errors include incorrect settings, and e-mail issues.

Incorrect settings can result from the wrong program being associated with a particular synchronization event. If you have Outlook installed on your PC, ActiveSync will most likely automatically assume that Tasks, E-mails, etc., should all be associated with Outlook. Verify that the programs you are using are associated with the type of synchronization you require.

E-mail issues usually stem from conflicts in address books, and conflicting settings in ActiveSync itself. To verify that e-mails get synchronized to and from the NETBOOK PRO correctly, verify that the e-mail addresses in the NETBOOK PRO outbox are valid. ActiveSync will provide some error text on synchronization to help you detect such problems. Conflicting settings in ActiveSync can result in e-mails being transferred as headers only, or without attachments. Check the settings for the ActiveSync service in Inbox on the NETBOOK PRO to resolve this issue.

## 7.3.2 Other Things To Try

1. Delete and recreate your partnership in ActiveSync.

When ActiveSync connects to a machine using a partnership for the first time, it uses the name “WindowsCE”. Every subsequent partnership created after the first asks you to enter a name for that machine. Partnerships register details about your NETBOOK PRO on your PC. Sometimes this information can become corrupt.

- Open ActiveSync by double-clicking on the **ActiveSync** icon in the PC’s system tray. This will bring up the *ActiveSync* dialog.

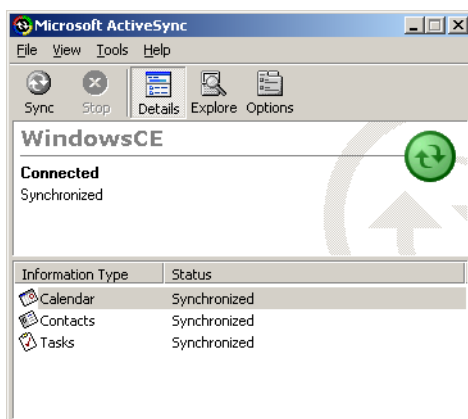

- Click on the *File* menu and select **Delete Partnership** from the menu. The *Delete Partnership* menu item will not be available if there are no partnerships.

If you have deleted all the partnerships, the next time you connect your NETBOOK PRO, the partnership will be created as “WindowsCE”.

2. Make a new backup and recreate any synchronizations.

8.1 Hardware Specifications . . . . .	115
8.1.1 Physical . . . . .	115
8.1.2 Environmental Characteristics . . . . .	115
8.1.3 Standard Display . . . . .	116
8.1.4 Power Requirements . . . . .	116
8.1.5 Standard Processor And Memory . . . . .	116
8.2 Standard Operating System . . . . .	116





*Note: Specifications are subject to change without notification.*

## 8.1 Hardware Specifications

### 8.1.1 Physical

Enclosure:	IP 30 Sub-notebook.
Dimensions:	235 x 184 x 35 mm (9.25 x 7.24 x 1.38 inches)
Weight:	1100 g / 2.95 lb. (incl. 2200 mAh battery pack)

### 8.1.2 Environmental Characteristics

Shock:	Withstands 0.7 m (2 ft.) drop onto carpet.
Dust and Water:	IP30 Rating.
Temperature Range:	
	<i>Operating</i>
	High                   +50°C (+122°F)
	Low                    -0°C (32°F)
	<i>Storage</i>
	High                   +60°C (+140°F)
	Low                    -10°C (14°F)
Relative Humidity:	<i>Operating</i> 0% to 93% maximum at 40°C, non-condensing.
EMI/RFI:	USA: FCC Part 15 Class B Europe: EN55022 Class B, EN 55024
Safety:	Complies with EN60950

### 8.1.3 Standard Display

High-quality SVGA size.

800 X 600 pixels 16-bit colour display with backlight.

### 8.1.4 Power Requirements

DC Power: Rechargeable: 2200 mAh 12.6 V Lithium-Ion battery pack, providing 8 to 14 hours operation.

Backup Battery: 2 AAA-size alkaline batteries.

AC Power: Adaptor for battery charging.

### 8.1.5 Standard Processor And Memory

Intel ARM-PXA 255 X-Scale, running at 400 MHz.

Internal ROM: 32 MB flash.

Internal RAM: 128 MB SDRAM.

### 8.1.6 Miscellaneous

Keyboard: 58 full-size keys, compact layout.

Data Storage: MultiMedia, Secure Digital, Compact Flash, and PCMCIA Card for expandable, removable data storage.

Pointing Device: Pen and touch-sensitive screen.

I/O: IrDA 1.1 (115 Kb/s).  
One RS-232 serial port (115 Kb/s).  
One USB mini type-A port for peripherals

Sound: Integrated headphone jack and speaker.

## 8.2 Standard Operating System

Operating System: Microsoft Windows<sup>®</sup> CE.NET.

Development Environment:

Compatible with Microsoft SDK for Win CE.NET.  
Fully supported by Psion Teklogix SDK for Mobile  
Devices.

Web Browser: Microsoft Internet Explorer.

PC Connectivity: Microsoft Active Sync.





## SUPPORT SERVICES AND WORLDWIDE OFFICES

Psion Teklogix provides a complete range of product support services to its customers worldwide. These services include technical support and product repairs.

### A.1 Technical Support

Technical Support for Mobile Computing Products is provided via e-mail through the Psion Teklogix customer and partner extranets. To reach the website, go to [www.psionteklogix.com](http://www.psionteklogix.com) and click on the appropriate Teknet link on the home page. Then click on the **Log-in** button or the **Register** button, depending on whether you have previously registered for Teknet. Once you have logged in, search for the “Support Request Form”.

### A.2 Product Repairs

#### *International*

For product repairs, please contact your local Psion Teklogix office (see page A-2).

#### *Canada/U.S.A*

Canadian and U.S. customers can receive access to repair services, by calling the toll-free number below, or via our secure website (see *Technical Support*, above).



**Note:** *Customers calling the toll-free number should have their Psion Teklogix customer number or trouble ticket number available.*

Voice: 1 800 387-8898 (press option “2”)

Fax: 1 905 812-6304

## A.3 WORLDWIDE OFFICES

### COMPANY HEADQUARTERS AND CANADIAN SERVICE CENTRE

#### **Psion Teklogix Inc.**

2100 Meadowvale Boulevard  
Mississauga  
Ontario  
Canada L5N 7J9  
Tel: +1 905 813 9900  
Fax: +1 905 812 6300  
E-mail: salescdn@psion.com

### NORTH AMERICAN HEADQUARTERS AND U.S. SERVICE CENTRE

#### **Psion Teklogix Corp.**

1810 Airport Exchange Boulevard  
Suite 500  
Erlanger, Kentucky  
USA 41018  
Tel: +1 859 371 6006  
Fax: +1 859 371 6422  
E-mail: salesusa@psion.com

### AMERICAS

#### **Psion Teklogix de Mexico, S.A. de C.V.**

Sierra Mojada 626, 2º Piso  
Col. Lomas Barrilaco, C.P. 11010  
Mexico, D.F., Mexico  
Tel: +52 55 5 327 1124  
Fax: +52 55 5 327 1123  
E-mail: salesusa@psion.com

#### **Psion Teklogix do Brasil, Ltda.**

Al. Casa Branca, 851 - conj. 101 e 102  
São Paulo - SP - 01408-001  
Brasil  
Tel: +55 11 3064 0868  
Fax: +55 11 3068 8198  
WWW: www.teklogixbrasil.com.br  
E-mail: tekbr@psion.com

#### **Psion Teklogix de Argentina, S.A.**

Avenida Moreau de Justo 1180  
Piso 1, Oficina C-105  
Buenos Aires 1107  
Argentina  
Tel: +54 11 4343 0193  
Fax: +54 11 4343 6310  
E-mail: tekar@psion.com

### INTERNATIONAL SUBSIDIARIES

#### **Psion Teklogix GmbH**

Jakob Kaiser Straße 3  
D-47877 Willich Münchheide  
Deutschland  
Tel: +49 2154 9282 0  
Fax: +49 2154 9282 59  
E-mail: info@teklogix.de

#### **Psion Teklogix S.A.**

La Duranne  
135 Rue Rene Descartes  
BP 421000  
13591 Aix-En-Provence  
Cedex 3; France  
Tel: +33 (0) 4.42.908.809  
Fax: +33 (0) 4.42.908.888  
E-mail: tekeuro@psion.com

#### **Psion Teklogix (UK) Ltd.**

Bourne End Business Centre  
Cores End Road  
Bourne End  
Buckinghamshire SL8 5AR, England  
Tel: +44 1628 648800  
Fax: +44 1628 648810  
WWW: www.teklogix.co.uk  
E-mail: tekuk@psion.com

#### **Psion Teklogix AB**

Stora Badhusgatan 18-20  
411 21 Göthenburg, Sweden  
Tel: +46 31 13 15 50  
Fax: +46 31 13 57 80  
E-mail: info@teklogix.se

#### **Psion Teklogix Danmark**

Vesterballevej 4-6  
7000 Fredericia  
Danmark  
Tel: +45 76 24 0133  
Fax: +45 75 94 4679  
E-mail: tedk@psion.com

#### **Psion Teklogix Italia S.r.l**

Via Galilei, 47  
20092 Cinisello Balsamo  
Milan, Italy  
Tel: +39 2 6604 5410  
Fax: +39 2 6604 5412  
E-mail: tkxitalia@psion.com

#### **Psion Teklogix Inc. (Singapore)**

583 Orchard Road  
# 15-01 Forum  
Singapore 238884  
Tel: +65 735 8108  
Fax: +65 733 5990  
E-mail: intl@psion.com

#### **Psion Teklogix España, S.L.**

Cityparc Ronda de Dalt  
Ctra. Hospitalet 147-149  
Edificio Atenas 2º 3ª  
08940 Cornellà de Llobregat (Barcelona)  
España  
Tel: +34 9 3475 0220  
Fax: +34 9 3475 0230  
E-mail: teklogix@apdo.com

**Psion Teklogix Africa**

Postnet Suite 39, Private Bag x11  
Halfwayhouse, 1685 Ground Floor East  
Waterfall Edge Phase 2, Waterfall Park  
Bekker Road MIDRAND 1685  
South Africa  
Tel: +27 11 805 7440/1/2  
Fax: +27 11 805 7444

**Psion Teklogix Systems India Pvt. Ltd.**

M-74, 1st Floor, "M" Block Market  
Greater Kailash-II  
New Delhi - 110048  
India  
Tel: +91 11 2621 9257  
Fax: +91 11 2621 9076  
E-mail: tekind@psion.com

**Psion Teklogix B.V.**

Venrayseweg 57,  
5928 NZ Venlo  
Nederlands  
Tel: +31 77 32400 44  
Fax: +31 77 32400 53

**Psion Teklogix Benelux**

Nieuwe weg 1,  
2070 Zwijndrecht  
Belgium  
Tel: +32 (0)3 250 22 00  
Fax: +32 (0)3 250 22 20  
E-mail: info@psionteklogix.be

**Psion Teklogix Wireless  
Technologies (Shanghai) Ltd.**

Unit 1507-08, Mingshen Building,  
No.3131 Kai Xuan Rd.  
Shanghai 200030, PRC  
Tel: +86-21-54071991  
Fax: +86-21-54071992

## A.4 WORLDWIDE WEB

[www.pSIONteklogix.com](http://www.pSIONteklogix.com)



# APPENDIX **B**

## PROGRAM LICENSE AGREEMENT

B.1 PROGRAM LICENSE AGREEMENT. . . . .	B-3
B.2 MICROSOFT END USER LICENSE AGREEMENT (EULA):	B-4



## **B.1 PROGRAM LICENSE AGREEMENT**

Your use of this product is based on your acknowledgement that you have read this license, understand it and agree to be bound by its terms and conditions.

This product includes software developed by and proprietary information of Psion Teklogix and its licensors. Software restrictions are as follows and shall be enforced to the fullest extent possible by applicable law:

1. License Restrictions.
  - a. You shall not, or permit any third party to: (i) use or duplicate the Software for any purpose other than as specified in the agreement; (ii) alter, reverse-engineer, decompile, disassemble or attempt to reconstruct or discover any source code or underlying ideas or algorithms of the Software by any means whatsoever; (iii) modify or create any derivative work of the Software or any copy or portion thereof; or (iv) remove or alter any software identification, notice of patent, copyright, trade secret, trademark or other proprietary right related to the Software.
  - b. You shall not distribute Software as a stand-alone product.
  - c. You may not use trademarks, logos, trade dress, or titles of Psion Teklogix or its licensors in any way, except as provided herein or with Psion Teklogix' express prior written permission.
2. No Warranty. THE SOFTWARE IS PROVIDED "AS IS" AND NEITHER PSION TEKLOGIX NOR ITS LICENSORS MAKE WARRANTIES OF ANY KIND, WHETHER EXPRESS, IMPLIED, OR STATUTORY REGARDING THE SOFTWARE. PSION TEKLOGIX AND ITS LICENSORS EXPRESSLY DISCLAIM ANY IMPLIED WARRANTIES OF MERCHANTABILITY, FITNESS FOR A PARTICULAR PURPOSE, FREE OF DEFECTS, TITLE FREE, NON-INFRINGEMENT OF INTELLECTUAL PROPERTY RIGHTS REGARDING THE SOFTWARE, AND ANY WARRANTY OTHERWISE ARISING OUT OF ANY PROPOSAL, SPECIFICATION OR SAMPLE. PSION TEKLOGIX AND ITS LICENSORS DO NOT WARRANT THAT THE SOFTWARE WILL MEET YOUR REQUIREMENTS OR THAT ITS USE WILL BE UNINTERRUPTED OR ERROR FREE.

**MICROSOFT END USER LICENSE AGREEMENT (EULA):**

3. **Limitation of Liability.** IN NO EVENT SHALL PSION TEKLOGIX OR ITS LICENSORS BE LIABLE FOR ANY DAMAGES WHATSOEVER, INCLUDING WITHOUT LIMITATION, DIRECT, INDIRECT, INCIDENTAL, CONSEQUENTIAL OR SPECIAL DAMAGES, LOSS OF PROFITS, REVENUE, LOSS OF BUSINESS, LOSS OF DATA OR LOSS OF USE, WHETHER SUCH CLAIM ARISES IN TORT OR CONTRACT AND IRRESPECTIVE OF WHETHER PSION TEKLOGIX OR ITS LICENSORS HAVE ADVANCE NOTICE OF THE POSSIBILITY OF SUCH DAMAGES.
4. **Ownership of Intellectual Property.** All title and intellectual property rights in the Software provided hereunder, and any copies of the Software, are owned by Psion Teklogix or its licensors. This agreement does not transfer to you any title in or ownership of the Software or any Psion Teklogix or third party trademarks, nor (except as provided herein) any right to use Psion Teklogix or third party copyrighted material, or confidential information embodied therein except the rights to use the Software as expressly permitted by this agreement.
5. **NOTE ON JAVA TECHNOLOGY.** The Software contains support for programs written in Java programming language. Java Technology is not fault tolerant and is not designed, manufactured or intended for use or resale as on-line control equipment in hazardous environments requiring fail-safe performance, such as in the operation of nuclear facilities, aircraft navigation or communication systems, air traffic control, certain medical devices, or weapons systems, in which the failure of Java Technology could lead directly to death, personal injury, or severe physical or environmental damage. Psion Teklogix and its licensors disclaim any express or implied warranties for any such use.

## **B.2 MICROSOFT END USER LICENSE AGREEMENT (EULA):**

You have acquired a device (“DEVICE”) that includes software licensed by Psion Teklogix Inc. from Microsoft Licensing Inc. or its affiliates (“MS”). Those installed software products of MS origin, as well as associated



media, printed materials, and “online” or electronic documentation (“SOFTWARE”) are protected by international intellectual property laws and treaties. The SOFTWARE is licensed, not sold. All rights reserved.

IF YOU DO NOT AGREE TO THIS END USER LICENSE AGREEMENT (“EULA”), DO NOT USE THE DEVICE OR COPY THE SOFTWARE. INSTEAD, PROMPTLY CONTACT PSION TEKLOGIX INC. FOR INSTRUCTIONS ON RETURN OF THE UNUSED DEVICE(S) FOR A REFUND. ANY USE OF THE SOFTWARE, INCLUDING BUT NOT LIMITED TO USE ON THE DEVICE, WILL CONSTITUTE YOUR AGREEMENT TO THIS EULA (OR RATIFICATION OF ANY PREVIOUS CONSENT).

**GRANT OF SOFTWARE LICENSE.** This EULA grants you the following license:

- You may use the SOFTWARE only on the DEVICE.
- NOT FAULT TOLERANT. THE SOFTWARE IS NOT FAULT TOLERANT. PSION TEKLOGIX INC. HAS INDEPENDENTLY DETERMINED HOW TO USE THE SOFTWARE IN THE DEVICE, AND MS HAS RELIED UPON PSION TEKLOGIX INC. TO CONDUCT SUFFICIENT TESTING TO DETERMINE THAT THE SOFTWARE IS SUITABLE FOR SUCH USE.
- NO WARRANTIES FOR THE SOFTWARE. THE SOFTWARE is provided “AS IS” and with all faults. THE ENTIRE RISK AS TO SATISFACTORY QUALITY, PERFORMANCE, ACCURACY, AND EFFORT (INCLUDING LACK OF NEGLIGENCE) IS WITH YOU. ALSO, THERE IS NO WARRANTY AGAINST INTERFERENCE WITH YOUR ENJOYMENT OF THE SOFTWARE OR AGAINST INFRINGEMENT. IF YOU HAVE RECEIVED ANY WARRANTIES REGARDING THE DEVICE OR THE SOFTWARE, THOSE WARRANTIES DO NOT ORIGINATE FROM, AND ARE NOT BINDING ON, MS.
- Note on Java Support. The SOFTWARE may contain support for programs written in Java. Java technology is not fault tolerant and is not designed, manufactured, or intended for use or resale as online control equipment in hazardous environments requiring fail-safe performance, such as in the operation of nuclear facilities, aircraft navigation or communication systems, air traffic control, direct life support machines, or weapons systems,

**MICROSOFT END USER LICENSE AGREEMENT (EULA):**

in which the failure of Java technology could lead directly to death, personal injury, or severe physical or environmental damage. Sun Microsystems, Inc. has contractually obligated MS to make this disclaimer.

- No Liability for Certain Damages. EXCEPT AS PROHIBITED BY LAW, MS SHALL HAVE NO LIABILITY FOR ANY INDIRECT, SPECIAL, CONSEQUENTIAL OR INCIDENTAL DAMAGES ARISING FROM OR IN CONNECTION WITH THE USE OR PERFORMANCE OF THE SOFTWARE. THIS LIMITATION SHALL APPLY EVEN IF ANY REMEDY FAILS OF ITS ESSENTIAL PURPOSE. IN NO EVENT SHALL MS BE LIABLE FOR ANY AMOUNT IN EXCESS OF U.S. TWO HUNDRED FIFTY DOLLARS (U.S.\$250.00).
- Limitations on Reverse Engineering, Decompilation, and Disassembly. You may not reverse engineer, decompile, or disassemble the SOFTWARE, except and only to the extent that such activity is expressly permitted by applicable law notwithstanding this limitation.
- SOFTWARE TRANSFER ALLOWED BUT WITH RESTRICTIONS. You may permanently transfer rights under this EULA only as part of a permanent sale or transfer of the Device, and only if the recipient agrees to this EULA. If the SOFTWARE is an upgrade, any transfer must also include all prior versions of the SOFTWARE.
- EXPORT RESTRICTIONS. You acknowledge that SOFTWARE is subject to U.S. export jurisdiction. You agree to comply with all applicable international and national laws that apply to the SOFTWARE, including the U.S. Export Administration Regulations, as well as end-user, end-use and destination restrictions issued by U.S. and other governments. For additional information see <http://www.microsoft.com/exporting/>.

# INDEX

**Boldface** indicates a parameter, menu or sub-menu name.

## A

- accessories
  - connecting USB accessories 28
- ActiveSync
  - about 5
  - backing up data 43
  - backup 69
  - connection problems 103
  - copying files 63, 67–69
  - Ethernet connection 42
  - guest connection 40
  - infrared serial connection 42
  - installing 103
  - partnership 40
  - RS232 serial connection 41
  - synchronizing files 63, 70–73
  - troubleshooting 111
- Advanced tab
  - Power Properties 21
- alt-tap
  - defined 14
- APN Manager** 82
- applications installed on the NETBOOK PRO 4
- attributes
  - of files 51

## B

- backing up data
  - through ActiveSync 43
- backlight properties 30
- Backlight to Minimum Level** (Power Properties) 18
- backup
  - battery, caring for 6
  - restoring files 43
  - to a PC 43
  - to multimedia cards 43
  - with ActiveSync 69
- backup batteries 24
- batteries

- backup 24
  - changing main battery 22
- battery
  - backup, caring for 6
  - calibration 16
  - charging times 103
  - fitting 22
  - internal backup 16, 24
  - life 102
  - Power Properties** 15
  - prolonging life 23
  - safety *xii, xiii*
  - Schemes** 18
  - status 16
- Baud Rate** 81
- Bluetooth Manager** 86
- Bluetooth radio
  - device service profiles 87
  - ISM band 85
  - radio configuration 86–88
- brightness control 30
- browsing folders 51

## C

- cab* files, installing 54
- calibration
  - batter 16
- cancelling a transfer 42
- Cards
  - type of 24
- cards
  - inserting CF 26
  - inserting MMC/SD 25
  - inserting PCMCIA 27
  - removing CF 26
  - removing MMC SD 25
  - removing PCMCIA 27
- care and safety 5
- CF Cards
  - inserting and removing 26
- changing

- main battery 22
- changing file attributes 51
- checkbox
  - Using Multiple Main Battery Packs 16
- city, setting location 39
- clicking (mouse terms) *See stylus*
- closing
  - folders 50
  - programs/files 50
  - programs and files 50
- Command Icons 29
- connecting NETBOOK PRO
  - to modem 94
  - with Ethernet (802.11b) 42
  - with Infrared (IrDA) 42
- connecting USB accessories 28
- contrast control 30
- Control Panel 44
  - exploring 44
- copying
  - files 52
  - files, using ActiveSync 67–69
  - folders 52
  - information between programs 36
- creating
  - files 51
  - folders 50
  - partnerships 70
- creating files 51
- creating folders 50

## D

- data
  - backing up 43
  - loss prevention 54
  - securing 45
  - transfer 40
- date, setting 39
- deleting
  - partitions 59
- device conflicts 106
- dialing, setting up 95
- dialogs
  - buttons 36
  - using 35
- dial-up account 90
- dimensions, NETBOOK PRO 115
- disks, viewing files 49
- dismounting

- partitions 59
- display, specifications 116
- displaying
  - amount of memory 55
  - control panel 44
- Display Off** (Power Properties) 18
- DNS, definition of 91
- double-click
  - stylus effect 13
- double-tap
  - defined 14
- double-tap, stylus effect 13
- drop rating 6
- DUN service, Bluetooth 87

## E

- e-mail 89
  - account 90
  - checklist 93
  - optional information 94
  - remote account 90
  - setting up 75, 94, 97
  - types of account 90
  - web-based account 90
- Emissions Information, Canada *xii*
- entering
  - data 34
  - owner information 39
- environmental specifications 115
- Ethernet connection 42
- Ethernet connection for ActiveSync 42

## F

- Fast IrDA 42
- fax/modem 108
- figure
  - Main Battery Insertion 22, 24
  - MMC insertion
  - NETBOOK PRO 11
  - Power Properties menus 16–21
- file attributes, changing 51
- files 34, 47
  - attributes 51
  - changing attributes 51
  - closing 50
  - copying 52
  - creating 51
  - memory use 55
  - moving around 49

- naming 51
  - navigating 33
  - opening 49, 50
  - viewing on disk 49
- fitting the main battery 22
- flash folder 54
- folders 47
  - closing 50
  - copying 52
  - creating 50
  - flash 54
  - managing 52
  - memory cards 53
  - moving around 49
  - naming 51
  - navigating 33
  - opening 49
- formatting
  - entire memory card 56
  - partitions 59

**G**

- Globetrotter Option radio card,
  - configuration 80
- glossary of terms 91
- GSM/GPRS radio
  - modem card 81
  - radio configuration 80–85
- guest connection, ActiveSync 40

**H**

- hard reset 32
- hardware specifications 115
- hostname, definition of 91
- How to
  - reset the NETBOOK PRO 102
  - see which programs are open 50
  - use Internet Explorer/Inbox 92
- humidity 7

**I**

- icon
  - power status, in taskbar 15
- icons, system command 30
- IMAP4, definition of 91
- Infrared
  - connection 42
  - device safety xii
  - Fast IrDA 42

- infrared serial connection for ActiveSync 42
- Input Panel** 34
- inserting
  - CF cards 26
  - MMC/SD cards 25
  - PCMCIA cards 27
- internal
  - backup battery 24
- Internet 89
  - account 90
  - setting up 75, 96
- IP address, definition of 91
- IP rating 6
- IP67 Rating 115
- IrDA *See Infrared*
- ISM band, Bluetooth radio 85
- ISP
  - definition 91
  - information 94

**K**

- keyboard
  - display 30
  - entering information 34
  - Input Panel** 34
  - languages 34
  - Software Input Panel 30

**L**

- LAN access using PPP service, Bluetooth 87
- languages, keyboard 34
- lithium-ion battery safety xiii
- location of stylus 13
- low temperature backlight setting 30

**M**

- magnetic fields 7
- mailbox
  - accounts 90
  - connecting to remote by modem 89
- main battery
  - fitting 22
- Make New Connection** 81
- managing folders 52
- MD5 Challenge** 79
- memory 116
  - additional 55

- card, additional programs 55
- displaying 55
- file sizes 55
- system 55
- use, checking 55
- memory card
  - creating partitions 57
  - folders 53
  - formatting entire 56
  - formatting partition 59
  - types of 24
- menu
  - Start 29
  - using 34
- Microsoft Windows CE.NET 116
- MMC
  - backup 43
- MMC/SD Cards
  - inserting and removing 25
- Mobile Device** 67
- modem
  - cable adaptor 95
  - connecting 94
  - setting up 96
  - troubleshooting 108
- mounting
  - partitions 60
- moving
  - highlight between files/folders 49
  - to a program 49
- multimedia cards *See MMC*

## N

- naming
  - files 51
  - folders 51
- NETBOOK PRO
  - care and safety 5
  - connecting to modem 94
  - front view 11
  - overview 4

## O

- On-Schedule Outlook Sync 73
- on-screen keyboard *See keyboard*
- opening
  - files 49
  - files and programs 49
  - folders 49

- operating
  - system 116
  - temperature 6

## P

- partitions
  - creating 57
  - deleting 59
  - dismounting 59
  - formatting 59
  - management 59
  - mounting 60
- partnership, ActiveSync 40
- partnerships 40
  - creating with ActiveSync 70
- password
  - at power on 12
- PC card radio
  - 802.11b configuration 77–80
- PCMCIA Cards
  - inserting and removing 27
- personal dial-up account 90
- Pocket On-Schedule 73
- POP3, definition 91
- power
  - management 14
  - Power Properties menus 16–21
  - requirements 116
  - specifications 116
  - status icon 15
- power management 14
- power-on password 12
- Power Properties
  - Advanced tab 21
- Power Properties** 15
- Power Scheme** 19
- Power state
  - Switch to Dim 19
  - Switch to Stand-By 19
  - Switch to Suspend 20
- Printer (serial service), Bluetooth 87
- printing, using PC 65
- processor specifications 116
- programs 34, 47
  - additional 55
  - closing 50
  - moving to 49
  - opening 49, 50
  - starting 34

**R**

- radio
  - Bluetooth 86–88
  - GSM/GPRS 80–85
  - 802.11b 77–80
- RAM 116
- remote e-mail account 90
- removing
  - CF cards 26
  - MMC/SD cards 25
  - PCMCIA Cards 27
- resetting NETBOOK PRO
  - hard 32
  - soft 31
- resetting the NETBOOK PRO
  - hard 32
  - soft 31
- restoring files from backup 43
- ROM 116
- RS232 serial connection for ActiveSync 41

**S**

- safety
  - battery *xii, xiii*
  - Infrared *xii*
  - instructions *xi*
  - summary *vii*
- Schemes (Power Properties)** 18
- screen
  - caring for 5
  - overview 29
- SDRAM 116
- Securing data 45
- securing your information 45
- Serial service, Bluetooth 87
- setting up
  - ActiveSync 40
  - dialing 95
  - e-mail 75, 94, 97
  - Internet service 75, 96
  - modem 96
  - time, date, home city 39
- single-tap
  - defined 14
- single-tap, stylus effect 13
- SMTP, definition of 91
- soft reset 31, 32
- Software Input Panel, keyboard 30

- specifications 113–117
  - display 116
  - environmental 115
  - IP30 Rating 115
  - operating system 116
  - physical 115
  - power 116
  - power requirements 116
  - processor 116
  - temperature range 115
- standard
  - display 116
  - processor and memory 116
- Start Menu 29
- static electricity 7
- status
  - battery 16
- Storage Manager 56
- storage temperature 6
- stylus
  - double-tap 13
  - location 13
  - single-tap 13
  - tap-and-hold 13
  - using 13

- Suspend (Power Properties)** 18
- switching off 12
- switching on 11
- Switch to**
  - Dim** 19
  - Stand-By** 19
  - Suspend** 20
- Switch to Dim 19
- Switch to Stand-By 19
- Switch to Suspend 20
- synchronizing files
  - ActiveSync 70–73
- system command icon 30
- system memory 55

**T**

- tap-and-hold, stylus effect 13
- TCP/IP, definition of 91
- temperature range, resetting NETBOOK PRO
  - soft 115
- temp folder 109
- text conventions 4
- time 39

**TLS** 79  
toolbar 29  
transferring information 40  
troubleshooting  
    ActiveSync 103, 111  
    fax/modem 108  
    for your NETBOOK PRO 104  
    for your PC 104  
    general tips 101  
    NETBOOK PRO basics 104  
    NETBOOK PRO on/off 101  
    passcode (password) 101  
    synchronization problems 111  
    temp folder 109  
    world times 101  
turning on/off 11, 28

## **U**

Using Multiple Main Battery Packs 16

## **W**

weight, NETBOOK PRO 115

802.11b

**IEEE 802.1X authentication** 79  
    radio configuration 77–80